



FS SYSTEM

Technical brochure
Folleto técnico

tempio[®]

INDEX

Perspectives 3
Perspectivas

Constructive details 9
Detalles constructivos

Pieces catalogue
Catálogo de piezas

FS-20 20

FS-24 23

FS-30 25

FS-L 2/20 27

FS-L 3/30 28

FS-L 4/24 29

FS-L 5/30 30

FS-L 7/30 31

FS-LP 2/30 32

FS-LP 3/30 33

FS-2B 5/30 34

FS-T 7/28 35



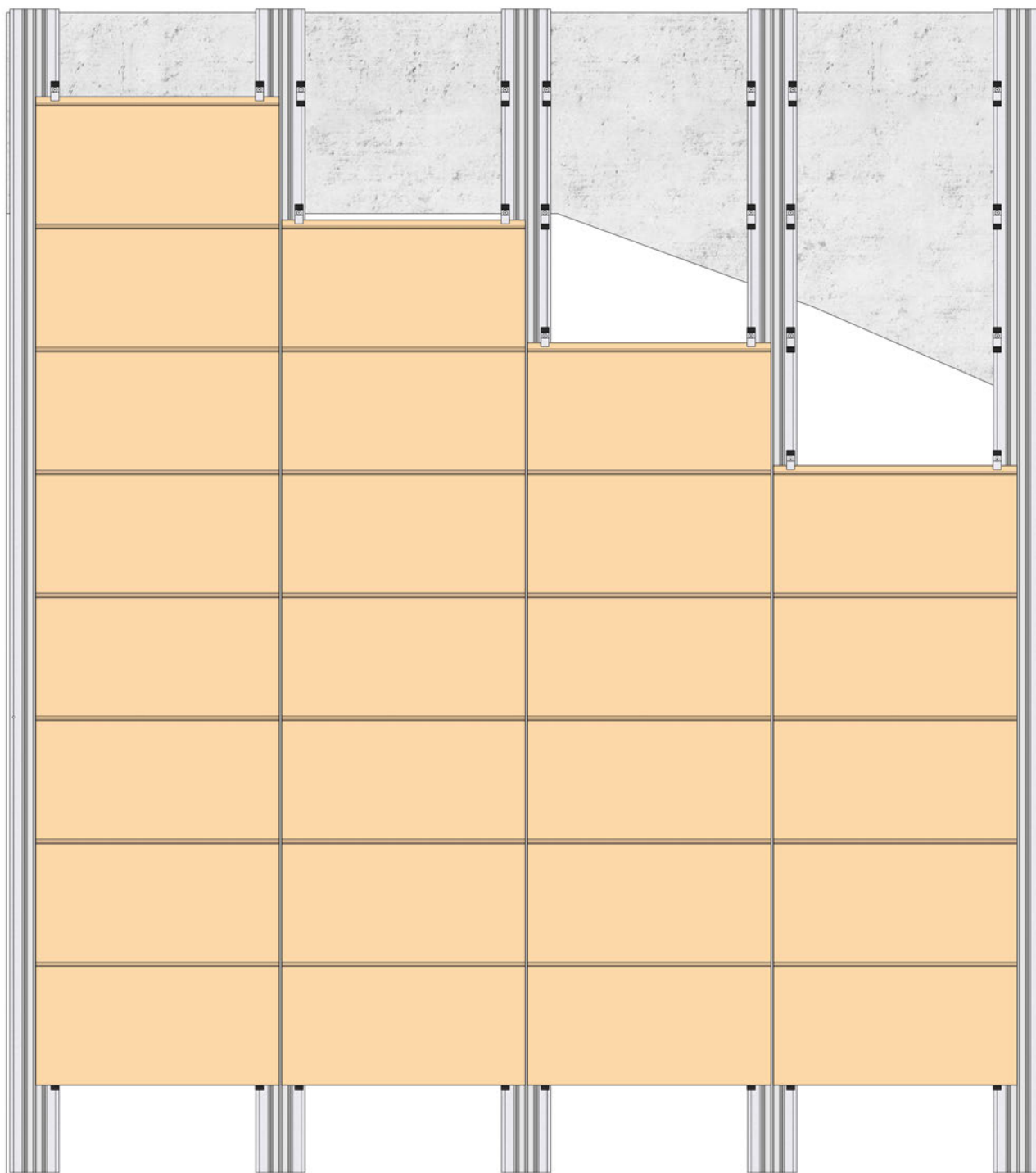

FS SYSTEM

System front view

Vista frontal del sistema

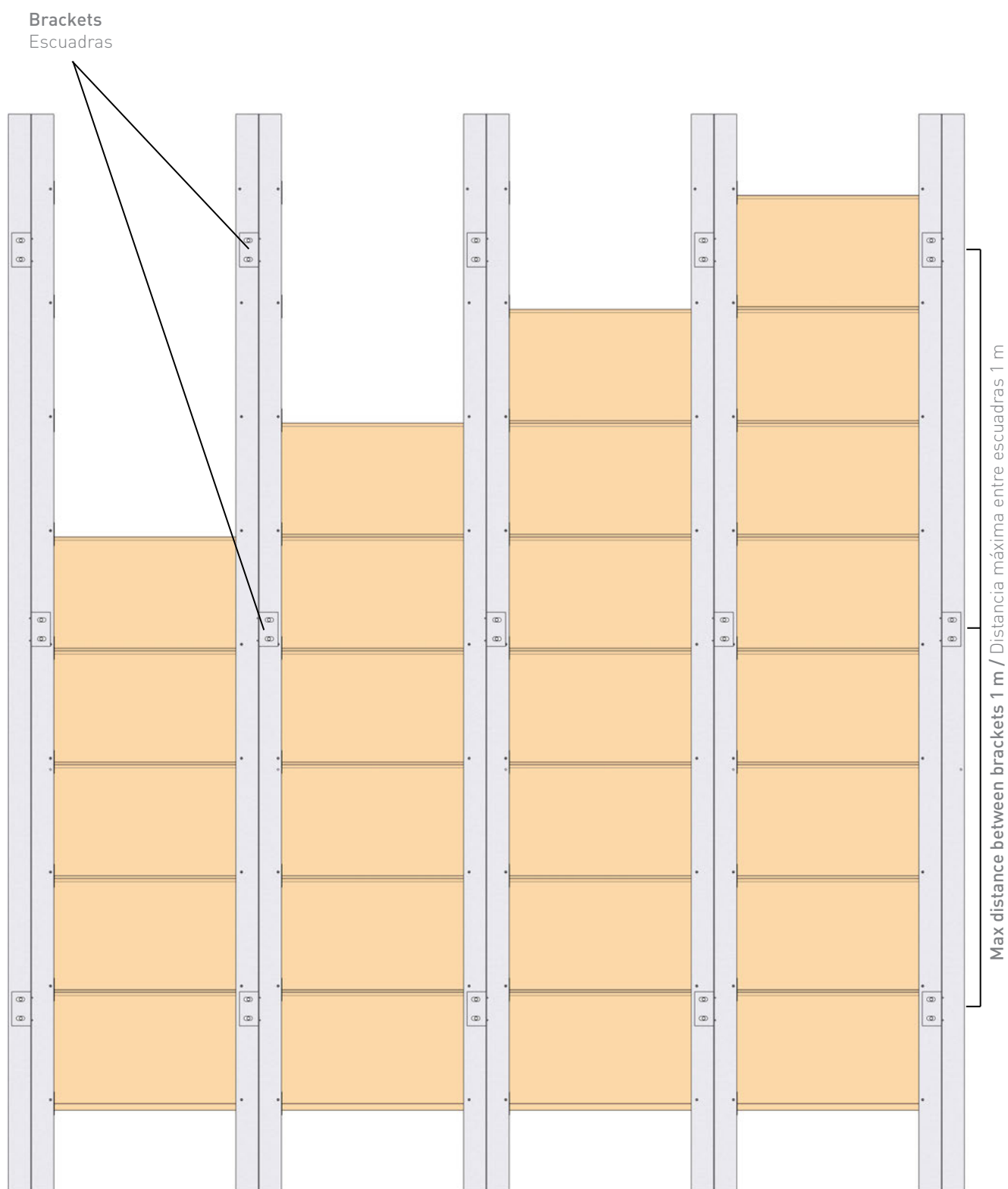

FS SYSTEM

System back view

Vista posterior del sistema

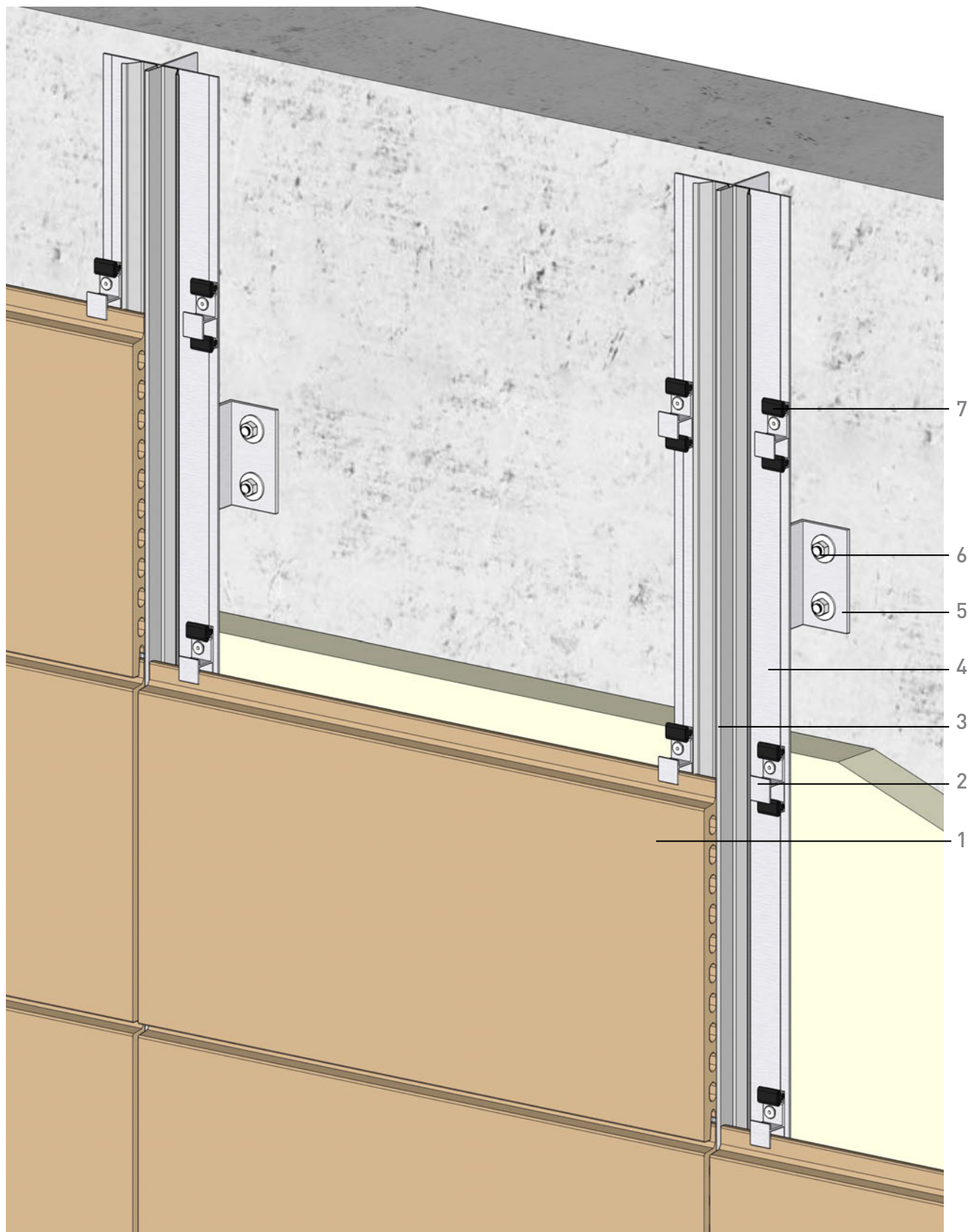

- 1. Tempio tile
Pieza Tempio
- 2. Clip
Grapa
- 3. Vertical joint profile
Perfil vertical de junta
- 4. Main T profile
Perfil T

- 5. Bracket
Ménsula
- 6. Anchorage
Anclaje
- 7. Anti-vibration rubber
Goma antivibración

FS SYSTEM

Perspective

Perspectiva

tempio®

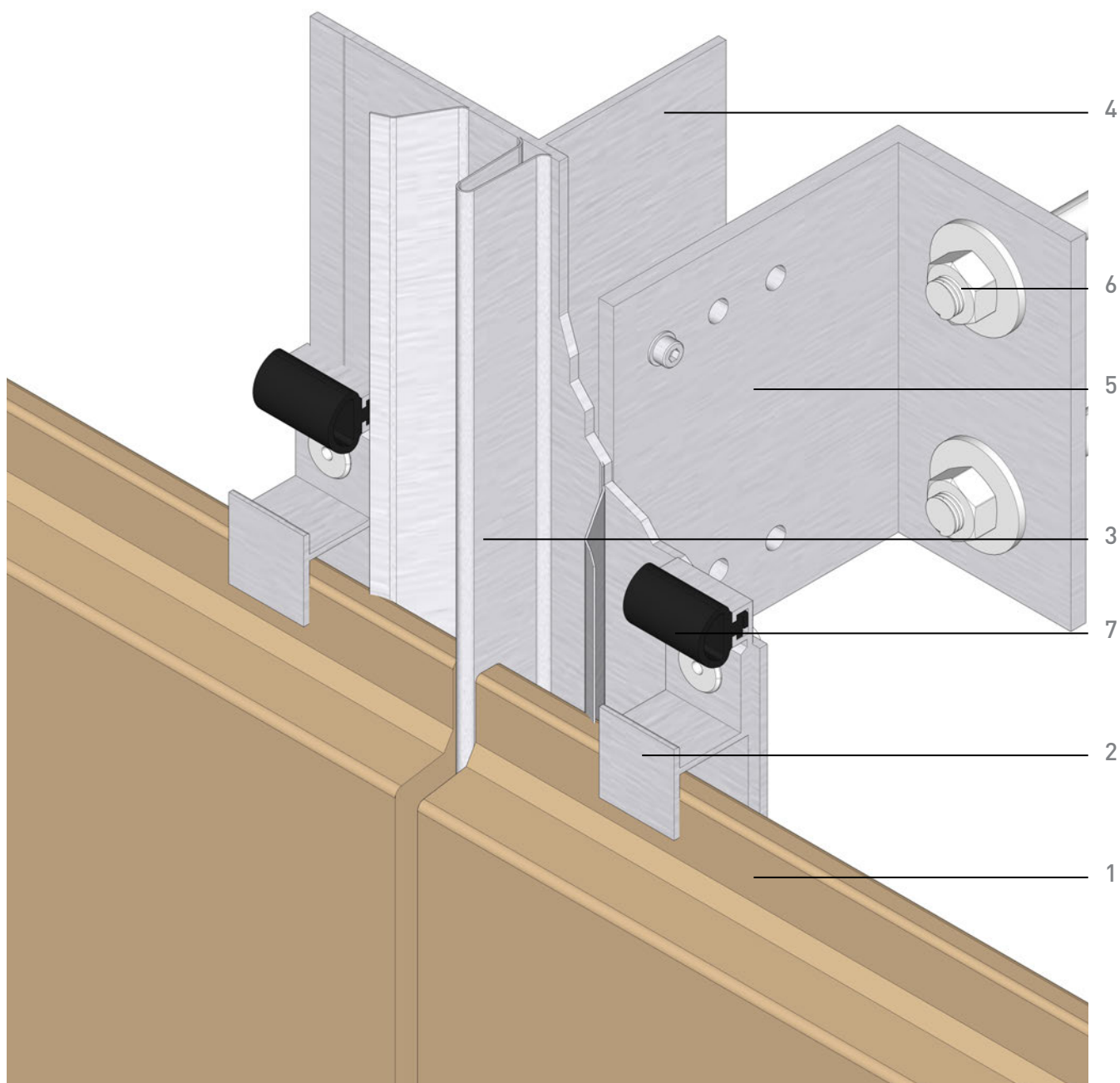

- 1. Tempio tile
Pieza Tempio
- 2. Clip
Grapa
- 3. Vertical joint profile
Perfil vertical de junta
- 4. Main T profile
Perfil T

- 5. Bracket
Ménsula
- 6. Anchorage
Anclaje
- 7. Anti-vibration rubber
Goma antivibración

FS SYSTEM

Joint detail

Detalle de junta

tempio®

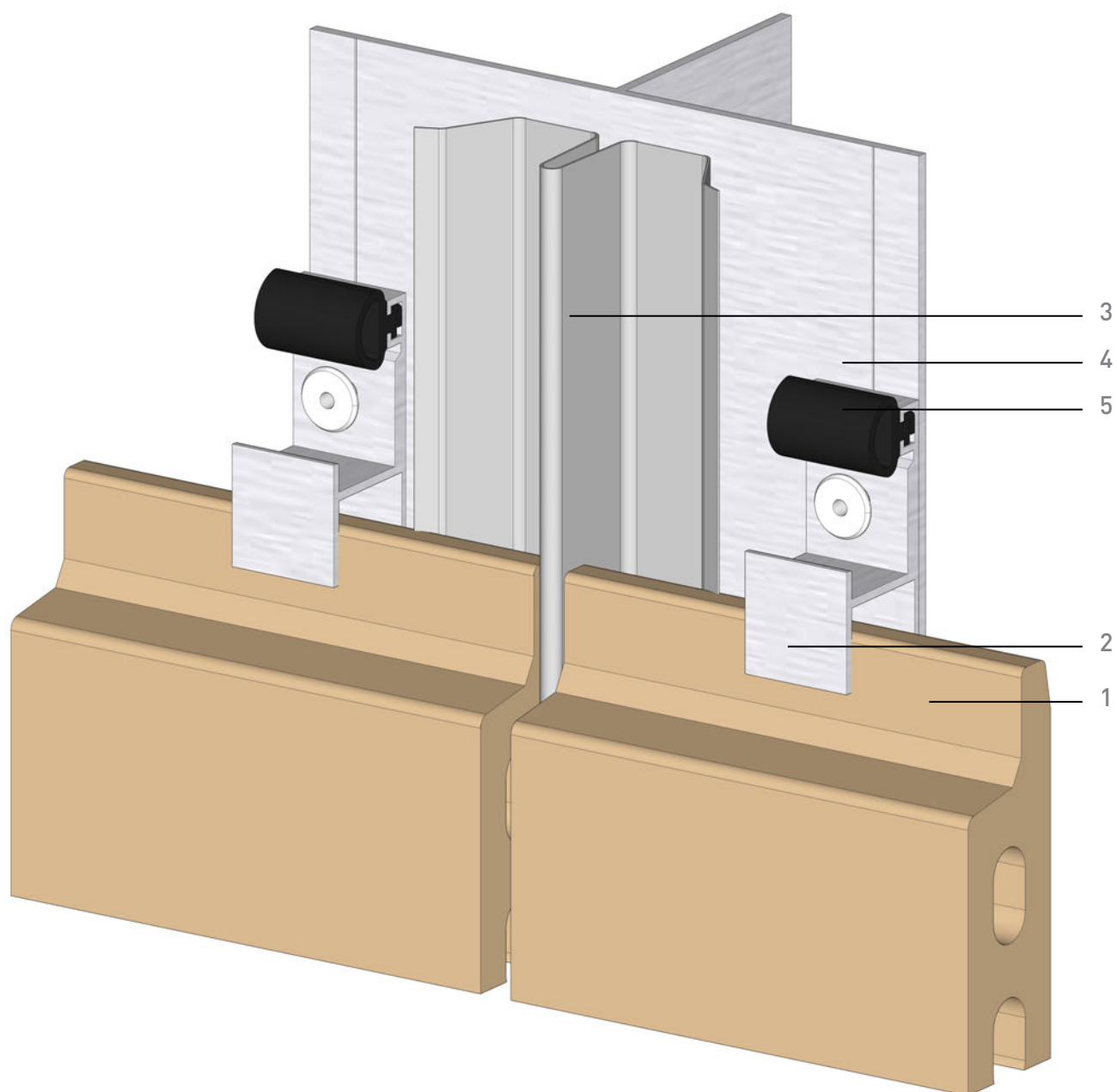

- 1. Tempio tile
Pieza Tempio
- 2. Clip
Grapa
- 3. Vertical joint profile
Perfil vertical de junta

- 4. Main T profile
Perfil T
- 5. Anti-vibration rubber
Goma antivibración

FS SYSTEM

Joint detail

Detalle de junta

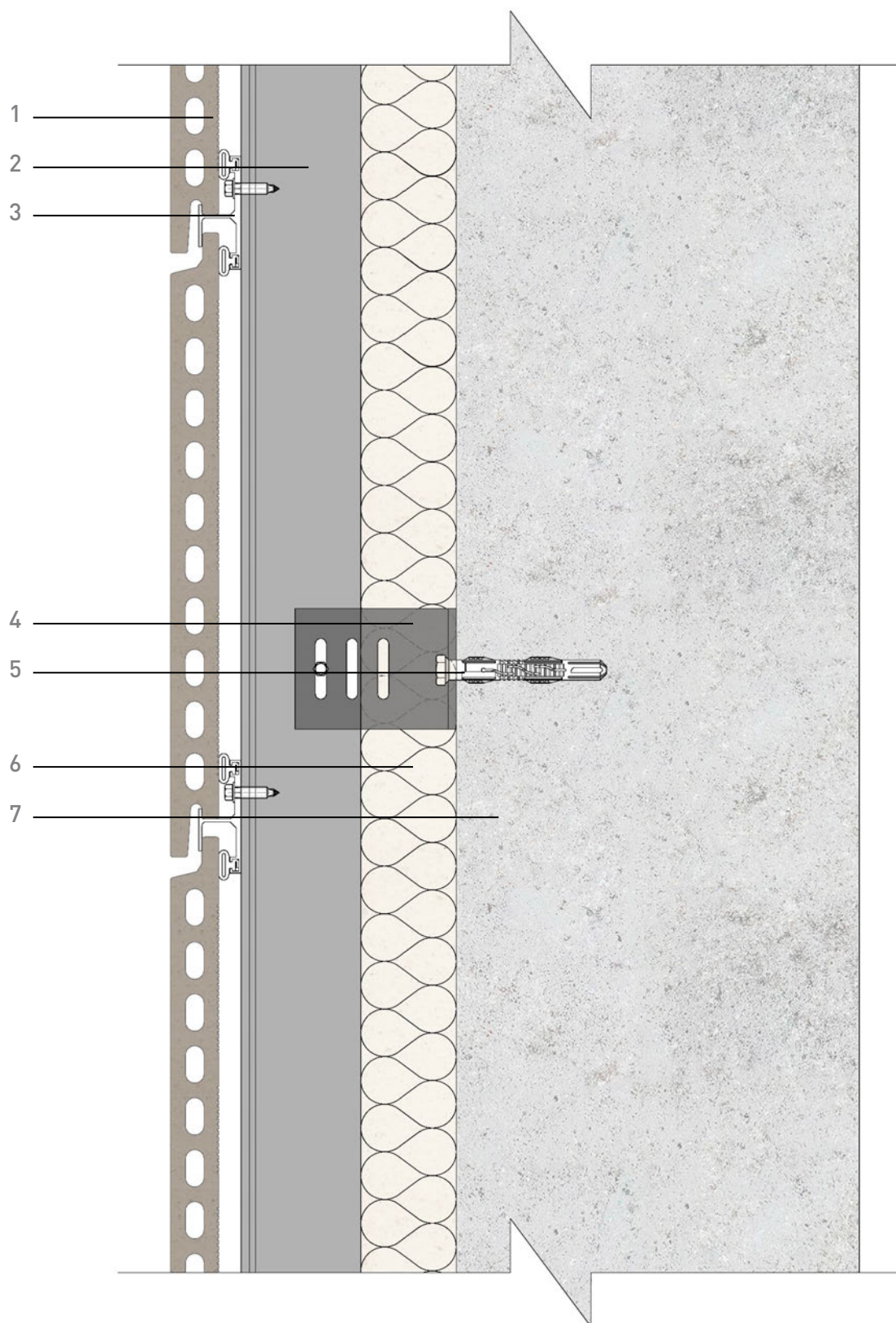

- | | |
|--|---------------------------------|
| 1. Tempio tile Pieza Tempio | 5. Anchorage Anclaje |
| 2. Vertical T profile Perfil T vertical | 6. Insulating layer Aislante |
| 3. Clip Grapa | 7. Wall Muro |
| 4. Bracket Ménsula | |

FS SYSTEM

Vertical section

Sección vertical

tempio®

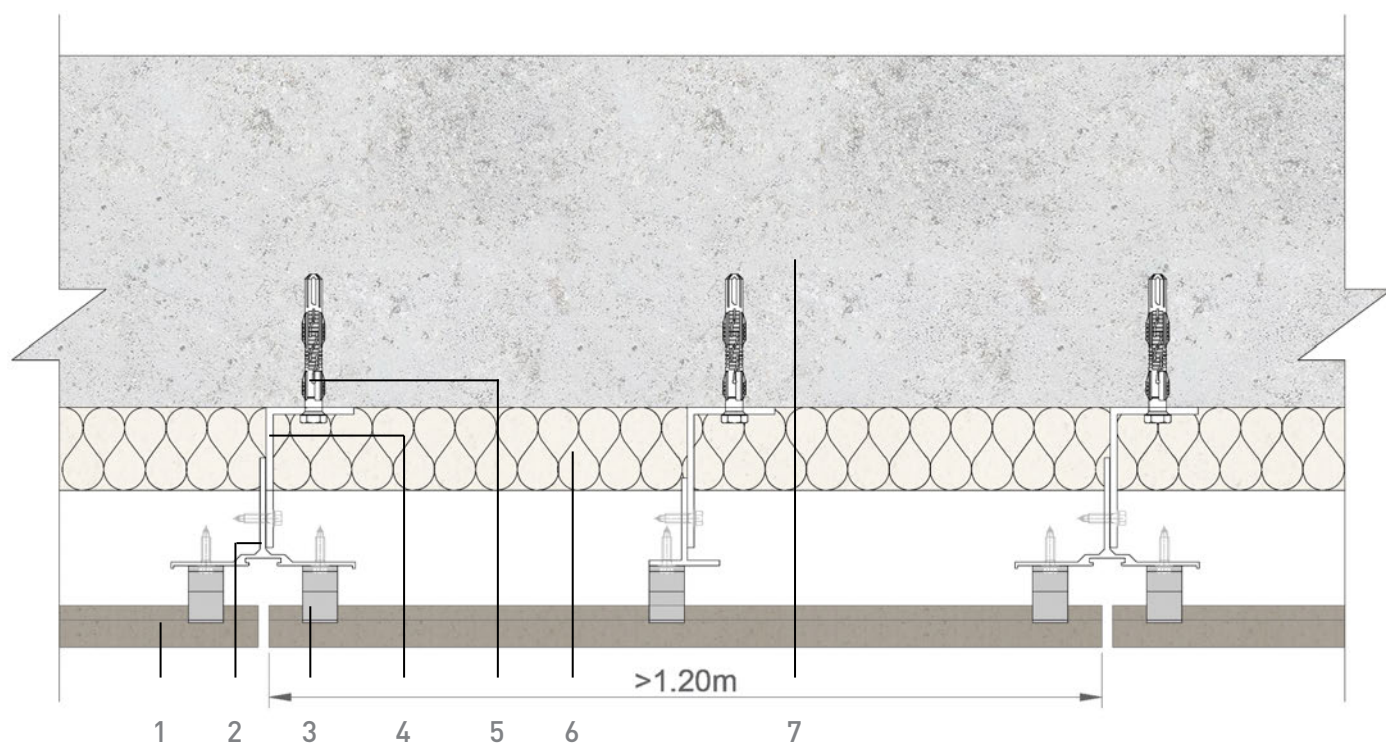
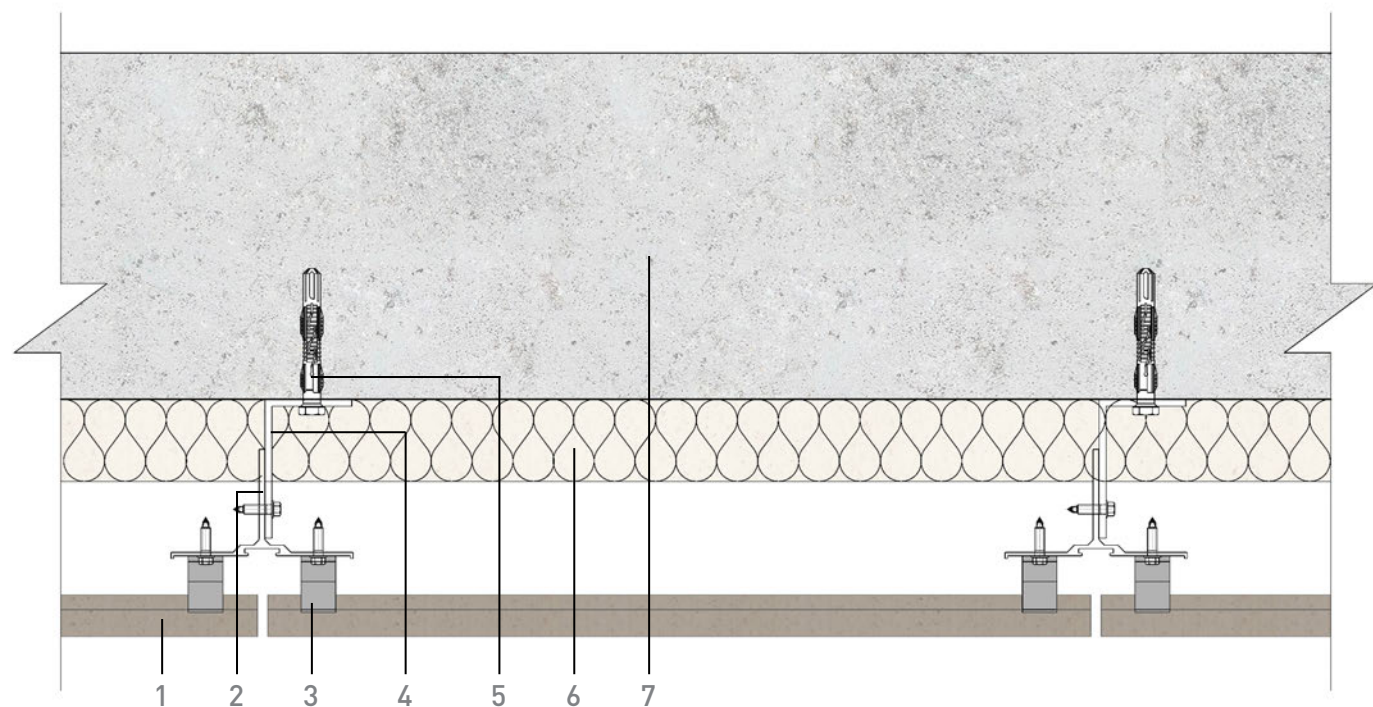

- | | |
|--|---------------------------------|
| 1. Tempio tile Pieza Tempio | 5. Anchorage Anclaje |
| 2. Vertical T profile Perfil T vertical | 6. Insulating layer Aislante |
| 3. Clip Grapa | 7. Wall Muro |
| 4. Bracket Ménsula | |

FS SYSTEM

Horizontal section
Sección horizontal

tempio®

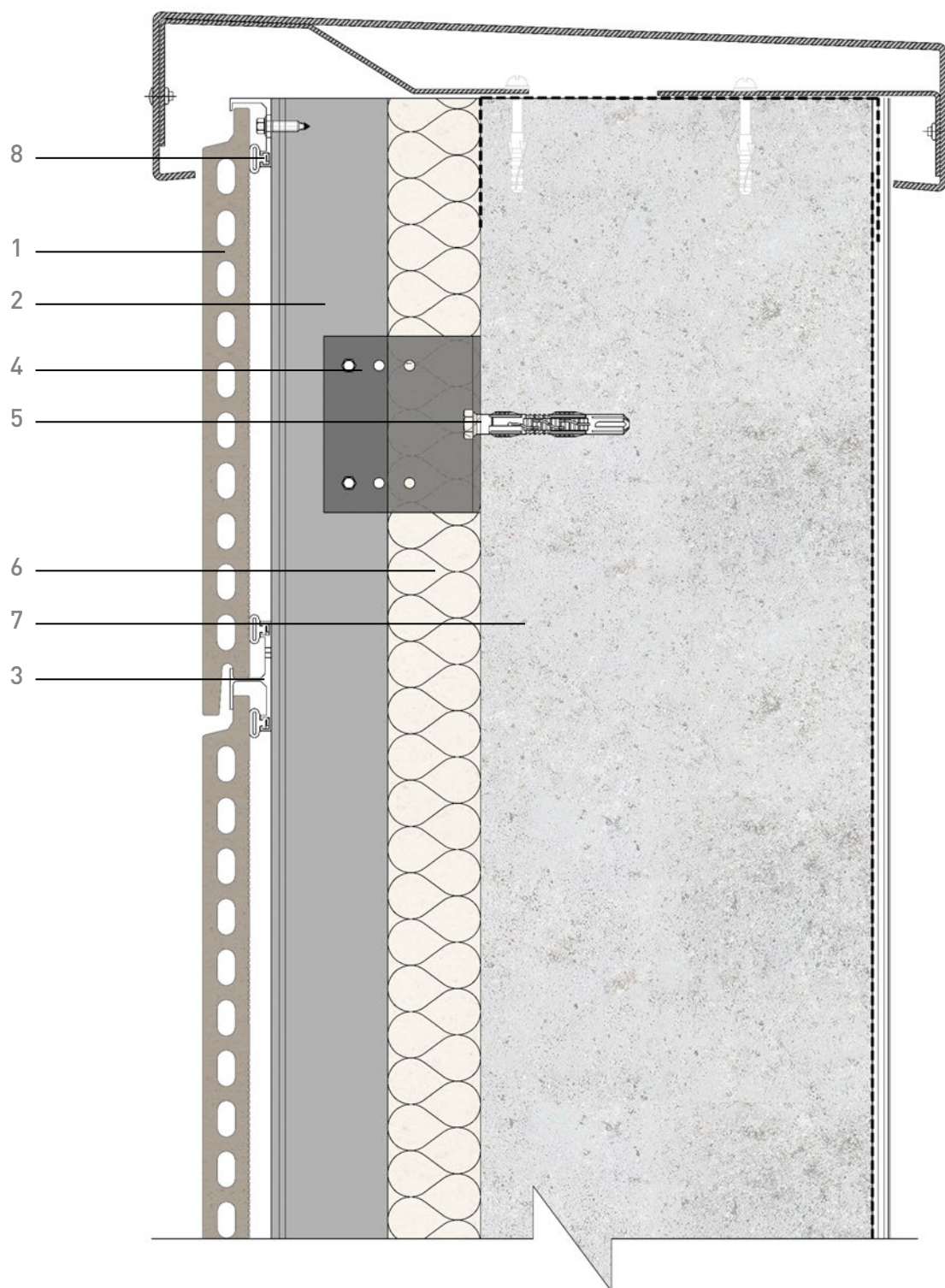

1. Tempio tile
Pieza Tempio

2. Vertical T profile
Perfil T vertical

3. Clip
Clip

4. Bracket
Ménsula

5. Anchorage
Anclaje

6. Insulating layer
Aislante

7. Wall
Muro

8. Termination clip
Clip de terminación

FS SYSTEM

Metallic coping

Coronación metálica

tempio®

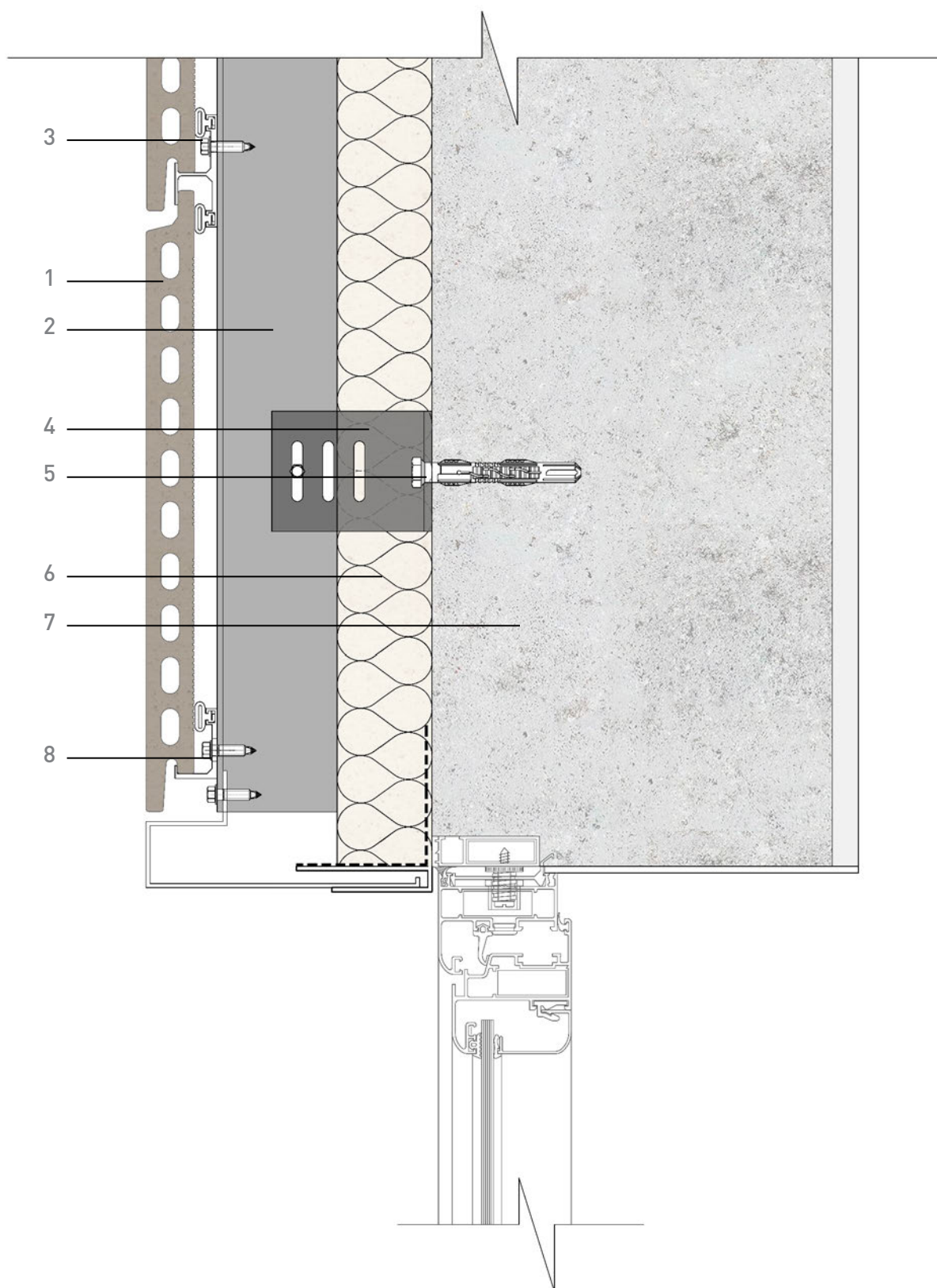

1. Tempio tile
Pieza Tempio

2. Vertical T profile
Perfil T vertical

3. Clip
Clip

4. Bracket
Ménsula

5. Anchorage
Anclaje

6. Insulating layer
Aislante

7. Wall
Muro

8. Termination clip
Clip de terminación

FS SYSTEM

Metallic lintel
Dintel metálico

tempio®

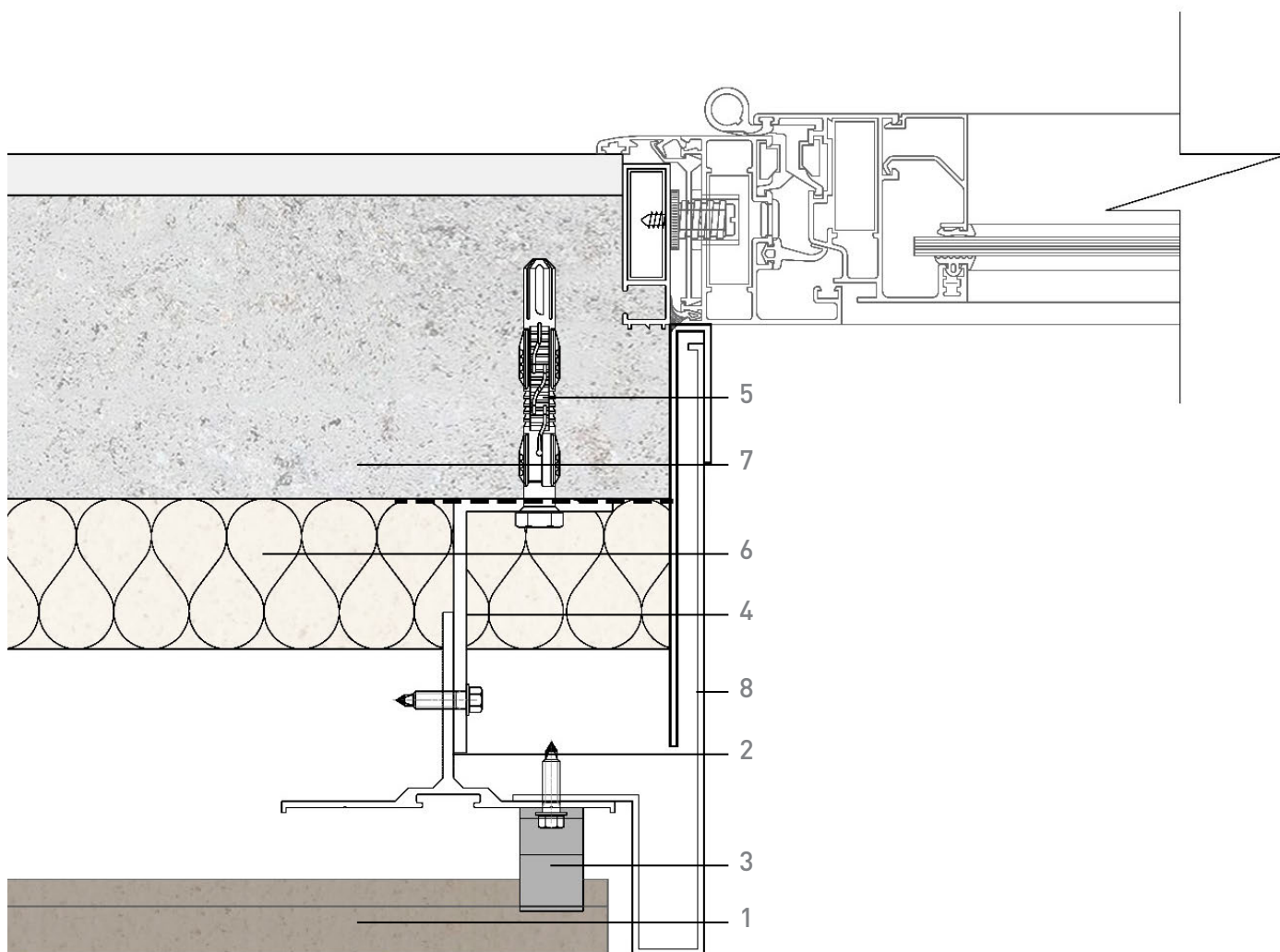

- | | | |
|--|---------------------------------|----------------------------------|
| 1. Tempio tile Pieza Tempio | 4. Bracket Ménsula | 7. Wall Muro |
| 2. Vertical T profile Perfil T vertical | 5. Anchorage Anclaje | 8. Metal sheet Chapa de metal |
| 3. Clip Grapa | 6. Insulating layer Aislante | |

FS SYSTEM

Window jamb
Jamba metálica

tempio®

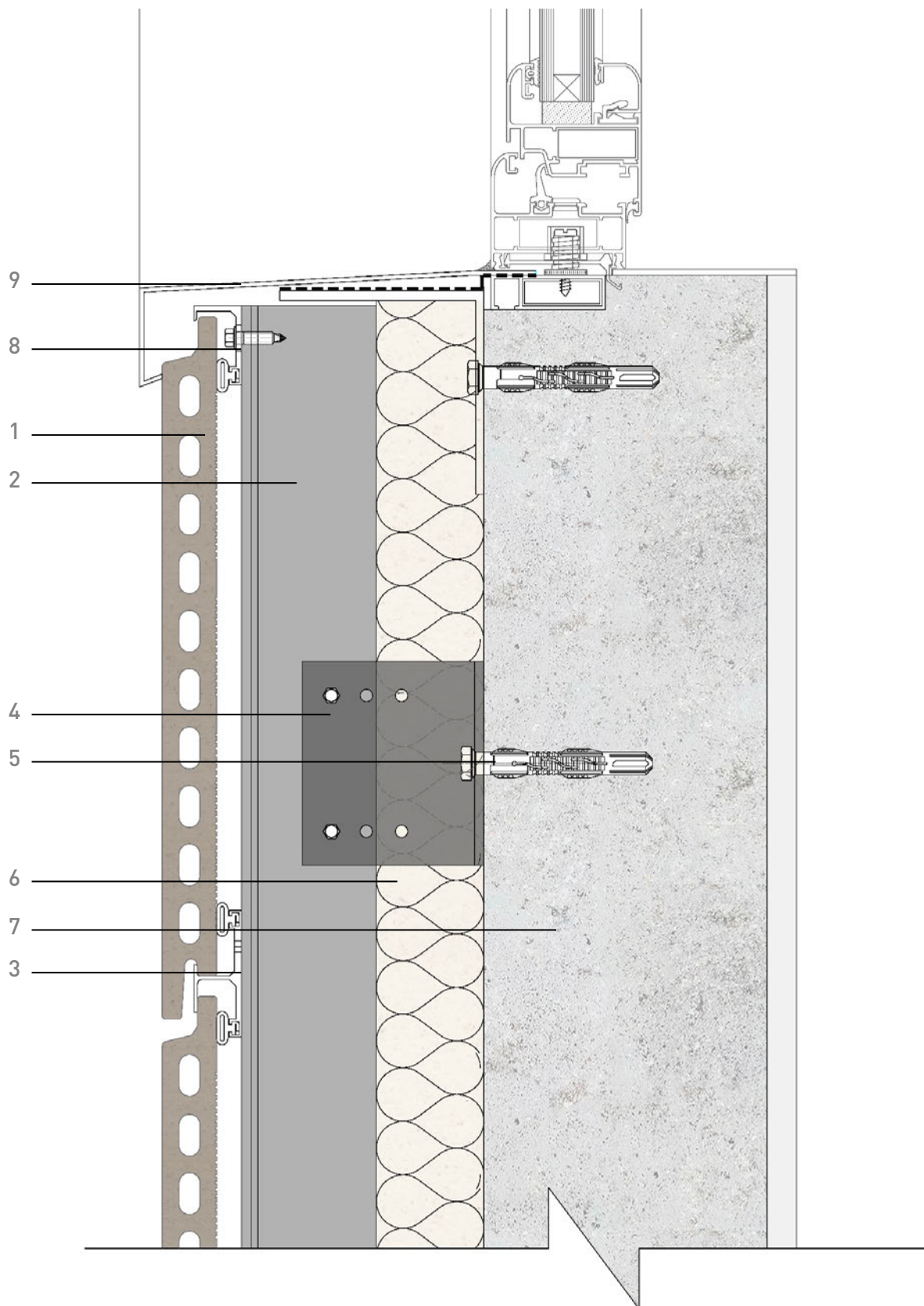

1. Tempio tile
Pieza Tempio

2. Vertical T profile
Perfil T vertical

3. Clip
Grapa

4. Bracket
Ménsula

5. Anchorage
Anclaje

6. Insulating layer
Aislante

7. Wall
Muro

8. Termination clip
Clip de terminación

9. Metal sheet
Chapa de metal

FS SYSTEM

Metallic sill

Vierteaguas metálico

tempio®

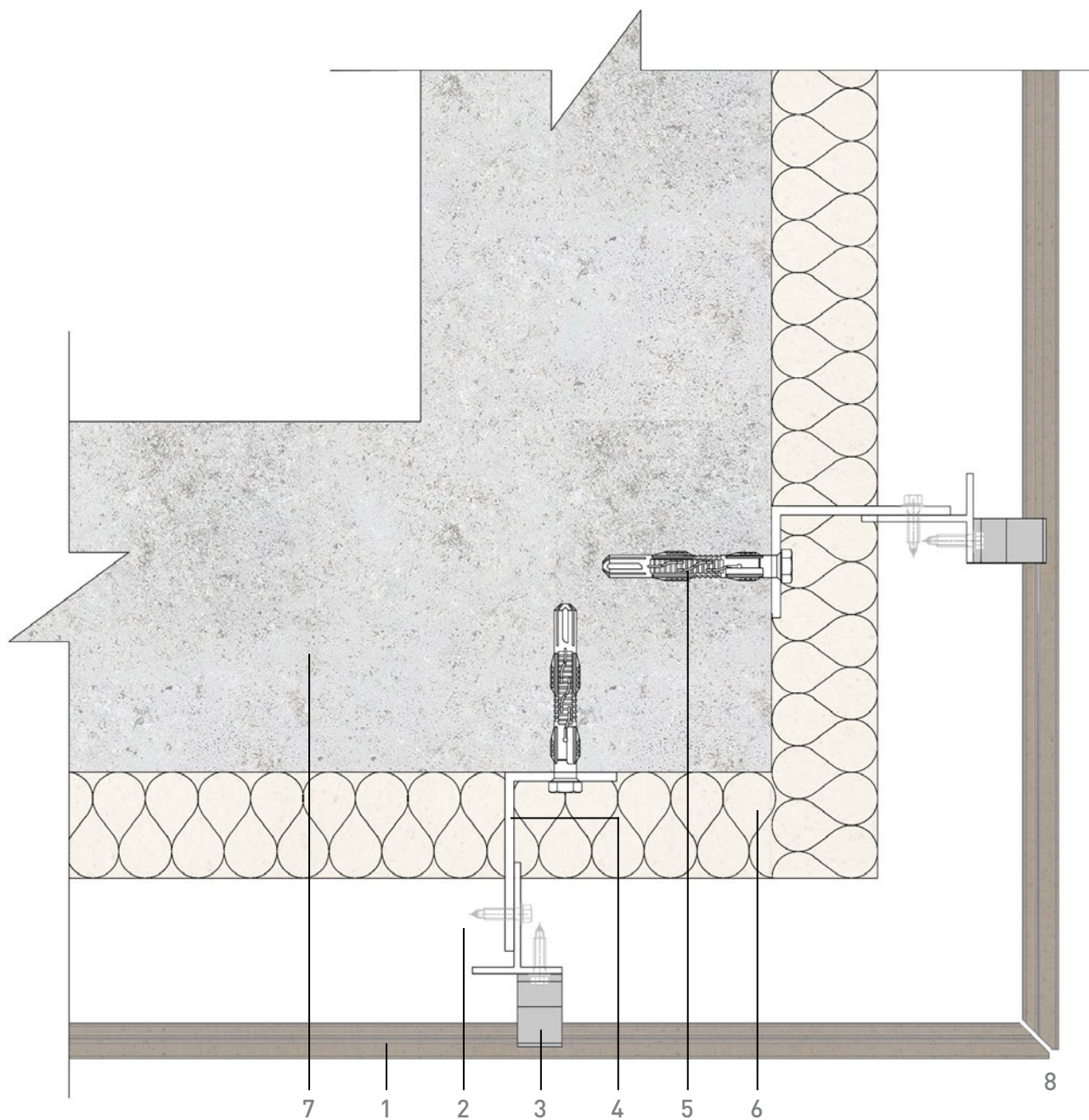

1. Tempio tile
Pieza Tempio

2. Vertical T profile
Perfil T vertical

3. Clip
Grapa

4. Bracket
Ménsula

5. Anchorage
Anclaje

6. Insulating layer
Aislante

7. Wall
Muro

8. Mitter cut
Corte en inglete

FS SYSTEM

Exterior corner

Esquina exterior

tempio®

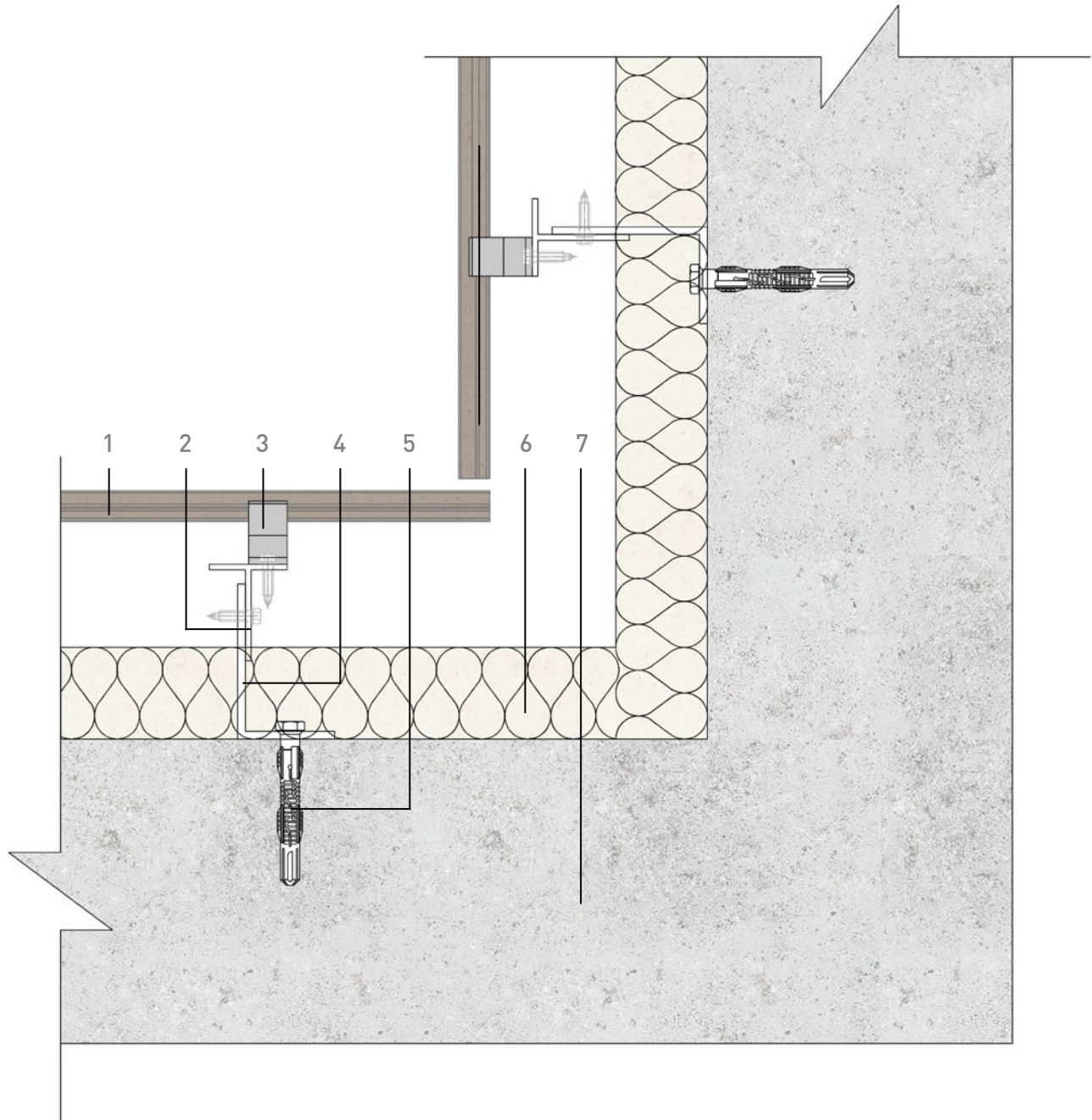

1. Tempio tile
Pieza Tempio

2. Vertical T profile
Perfil T vertical

3. Clip
Grapa

4. Bracket
Ménsula

5. Anchorage
Anclaje

6. Insulating layer
Aislante

7. Wall
Muro

FS SYSTEM

Interior corner

Esquina interior

tempio®

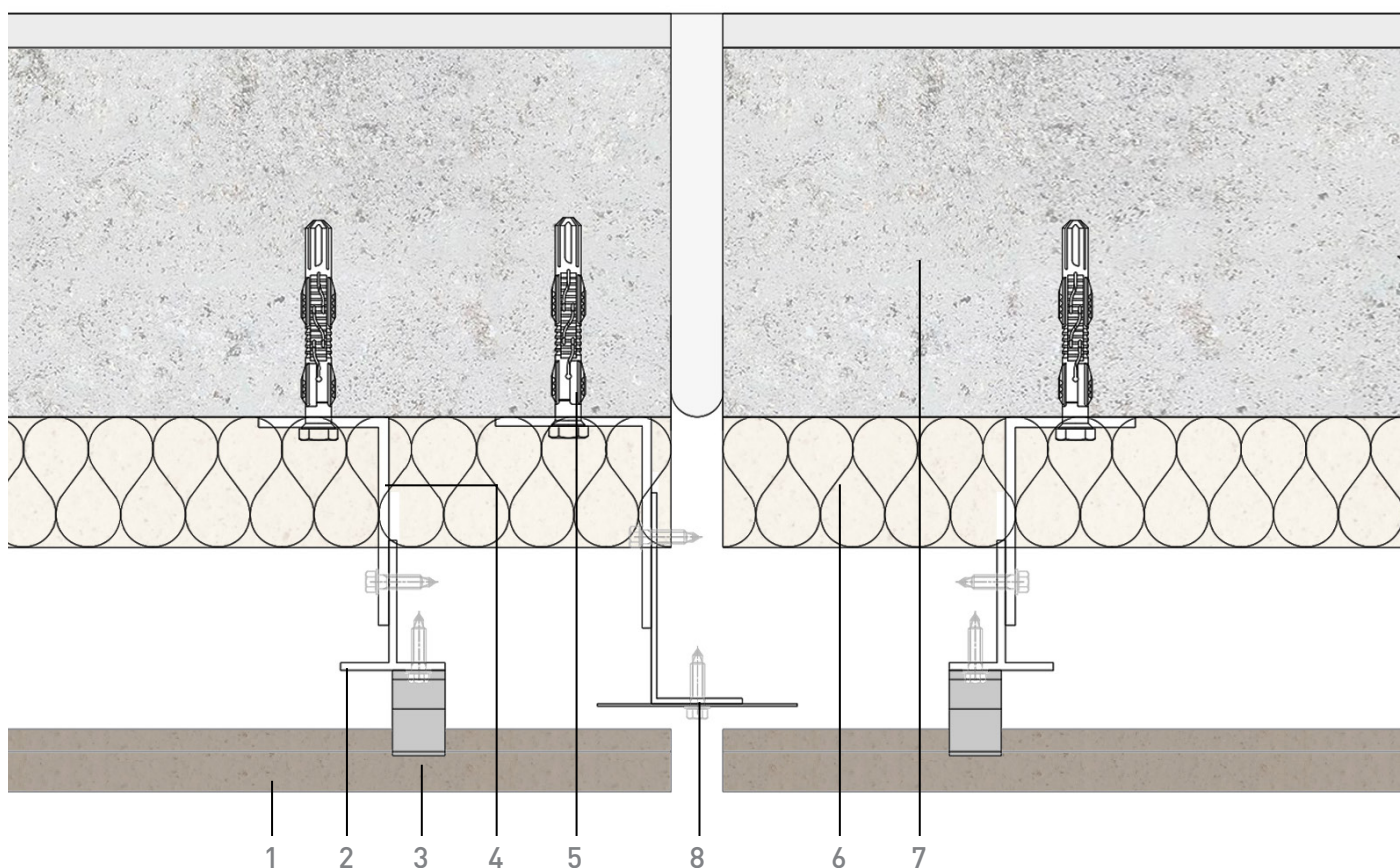

- | | |
|--|----------------------------------|
| 1. Tempio tile Pieza Tempio | 5. Anchorage Anclaje |
| 2. Vertical T profile Perfil T vertical | 6. Insulating layer Aislante |
| 3. Clip Grapa | 7. Wall Muro |
| 4. Bracket Ménsula | 8. Metal sheet Chapa de metal |

FS SYSTEM

Dilatation joint

Junta de dilatación

tempio®

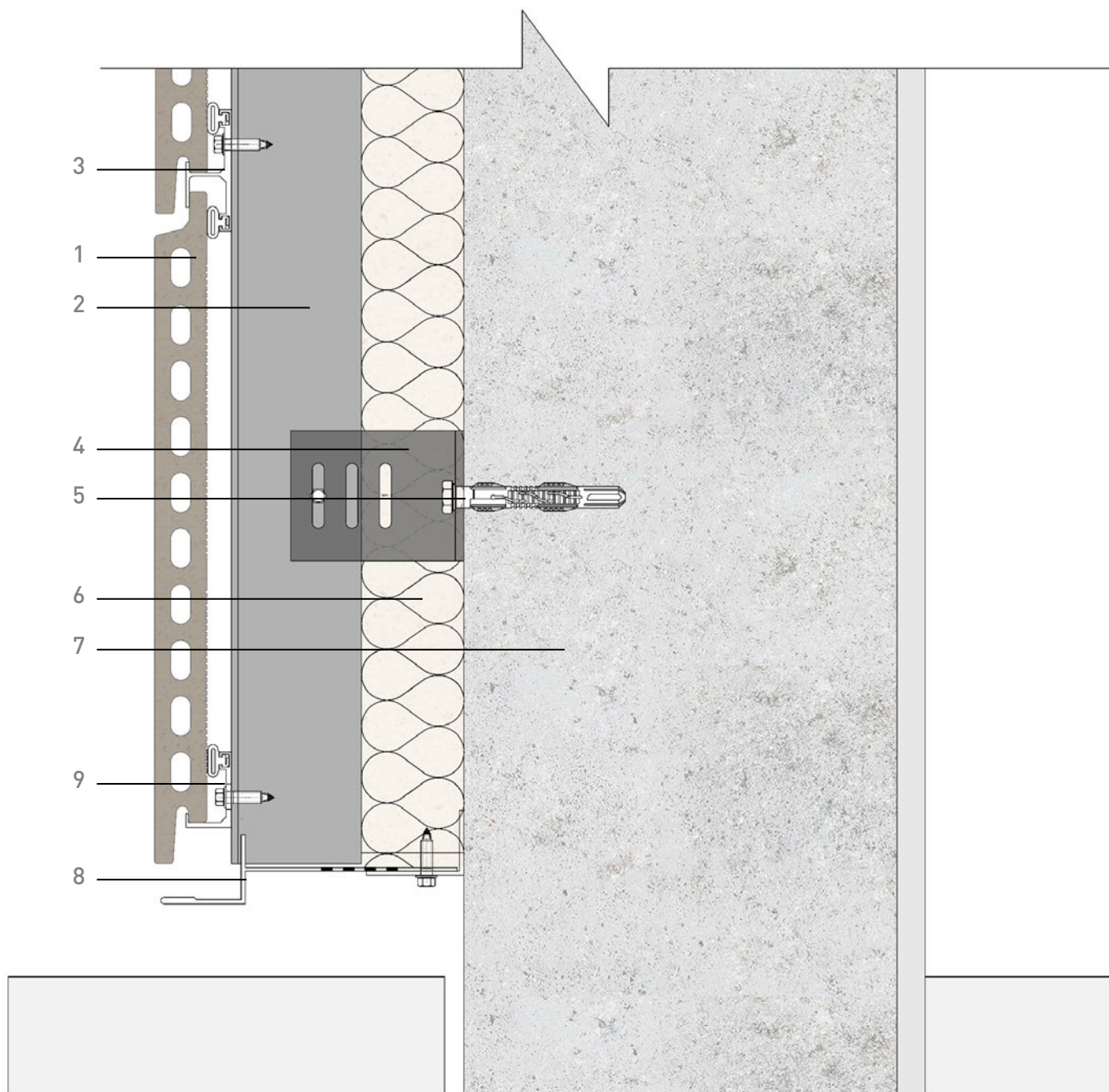

1. Tempio tile
Pieza Tempio

2. Vertical T profile
Perfil T vertical

3. Intermediate clip
Clip intermedio

4. Bracket
Ménsula

5. Anchorage
Anclaje

6. Insulating layer
Aislante

7. Wall
Muro

8. Perforated metal profile
Chapa metal perforada

9. Termination clip
Clip de terminación

FS SYSTEM

Termination

Terminación

tempio®

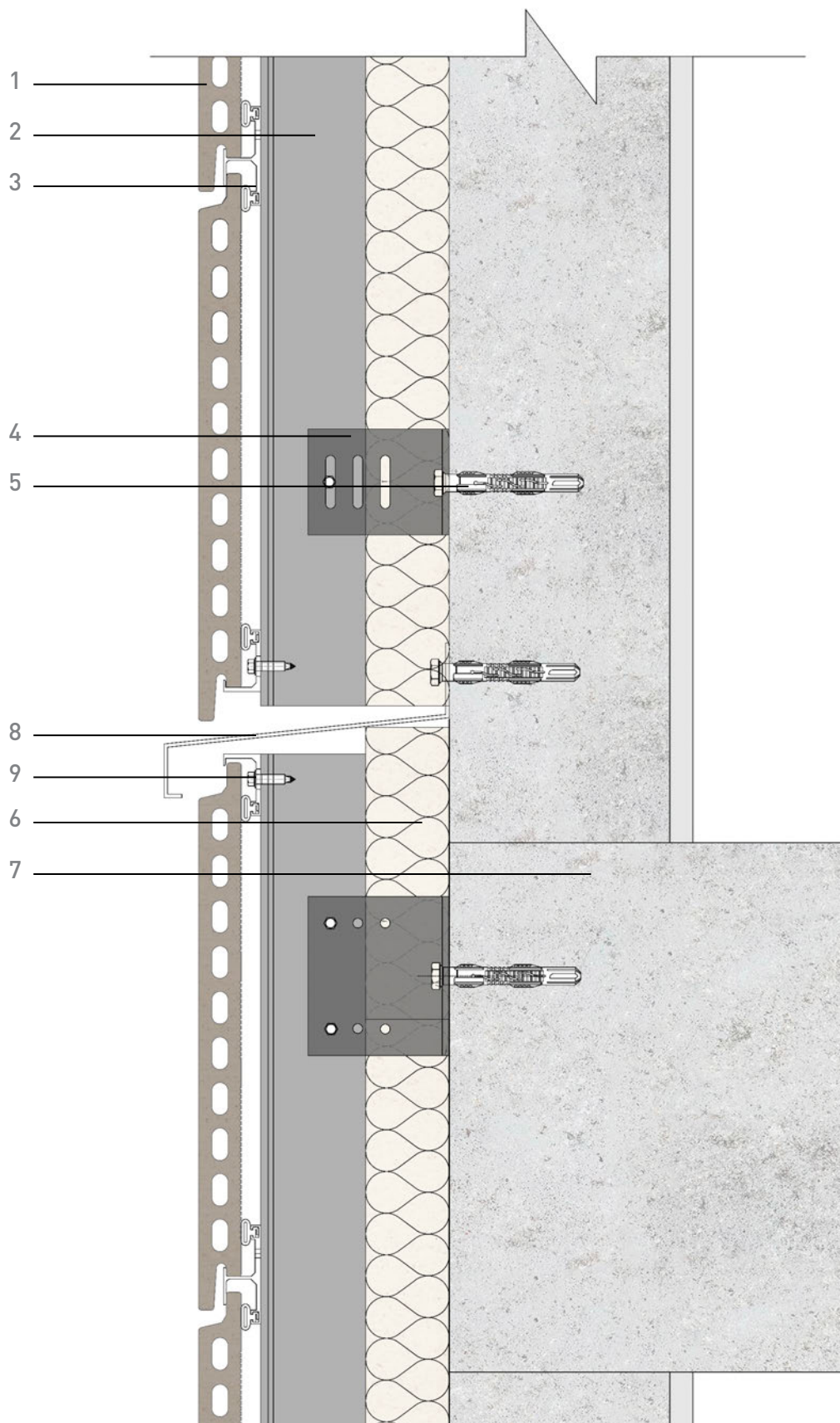

- | | | |
|--|---------------------------------|--|
| 1. Tempio tile Pieza Tempio | 4. Bracket Ménsula | 7. Wall Muro |
| 2. Vertical T profile Perfil T vertical | 5. Anchorage Anclaje | 8. Metal profile Chapa metal |
| 3. Intermediate clip Clip intermedio | 6. Insulating layer Aislante | 9. Termination clip Clip de terminación |

FS SYSTEM

Cortafuegos
Firewall

tempio®

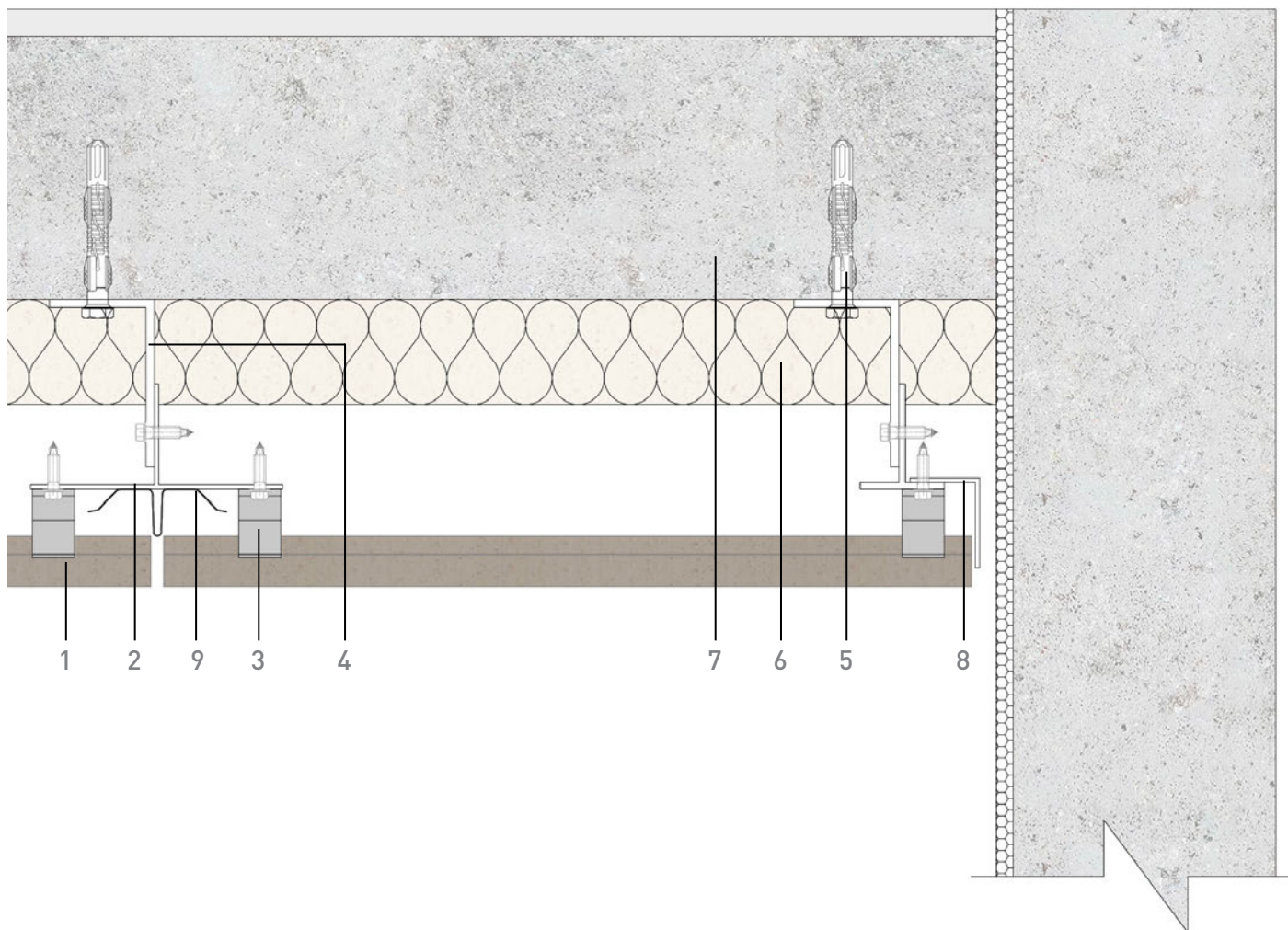

- | | | |
|--|---------------------------------|--|
| 1. Tempio tile Pieza Tempio | 4. Bracket Ménsula | 7. Wall Muro |
| 2. Vertical T profile Perfil T vertical | 5. Anchorage Anclaje | 8. Finishing profile Angular de terminación |
| 3. Clip Grapa | 6. Insulating layer Aislante | 9. Joint profile Perfil de junta |

FK SYSTEM

Side termination

Terminación lateral

tempio®

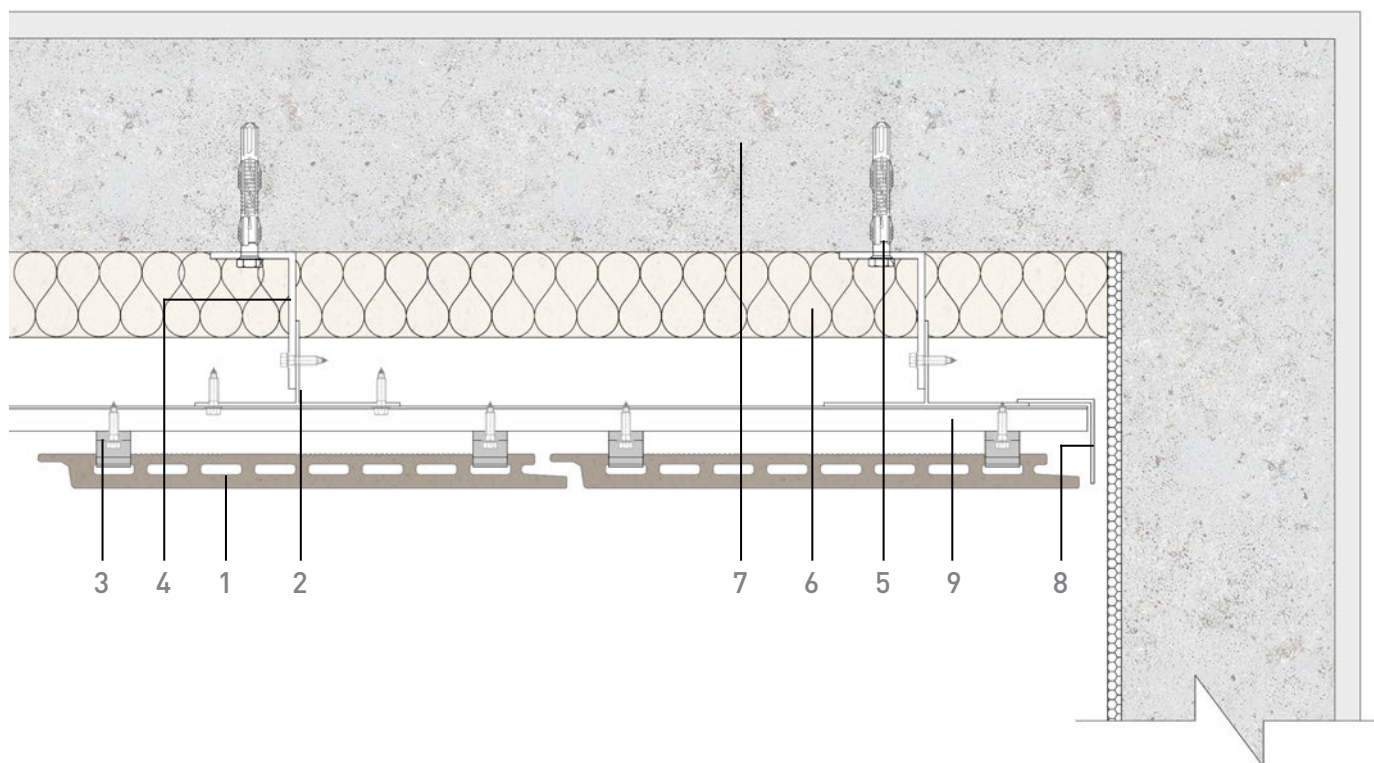

- | | | |
|--|---------------------------------|-------------------------------------|
| 1. Tempio tile Pieza Tempio | 4. Bracket Ménsula | 7. Wall Muro |
| 2. Vertical T profile Perfil T vertical | 5. Anchorage Anclaje | 8. Metal sheet Chapa de metal |
| 3. Clip Grapa | 6. Insulating layer Aislante | 9. Hat list profile Perfil Omega |

FS SYSTEM

Side termination

Terminación lateral

tempio®

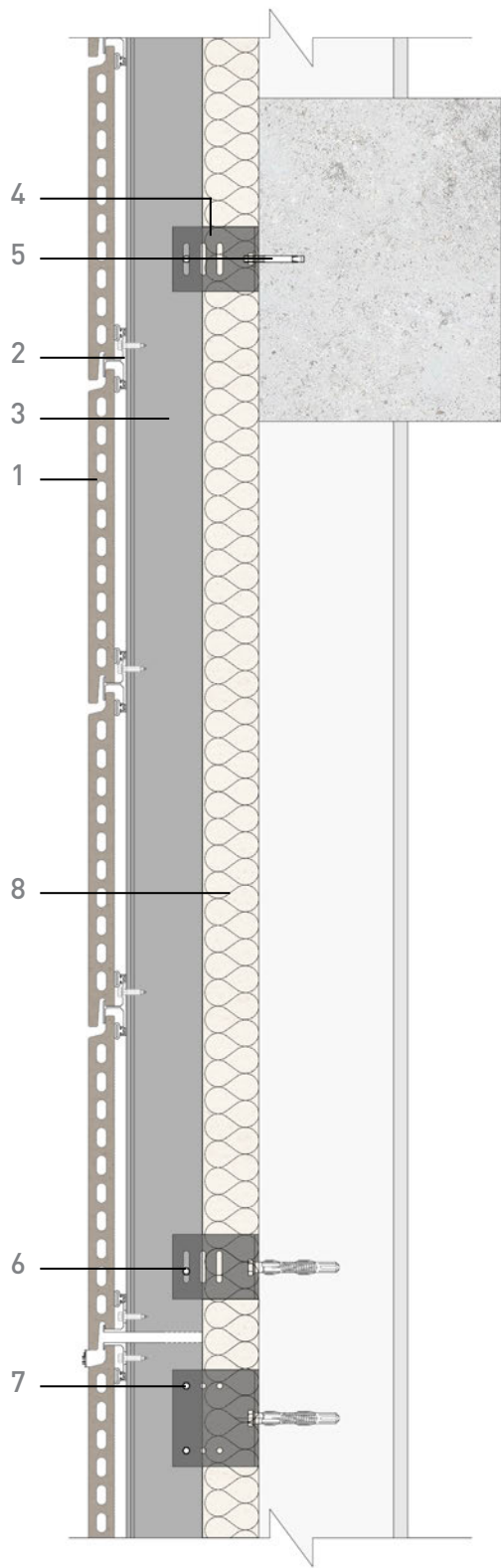

A. Vertical section
Sección vertical

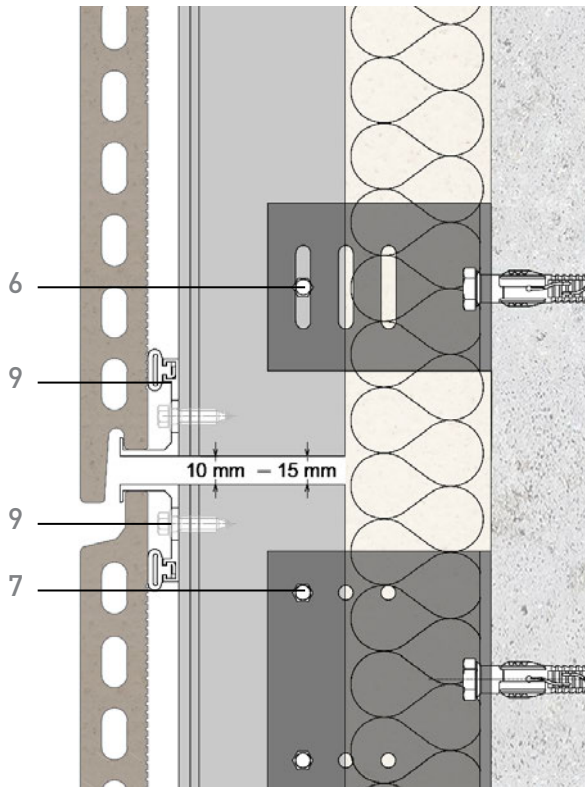

B. Detail of mounting fixings
Detalle de montaje de fijaciones

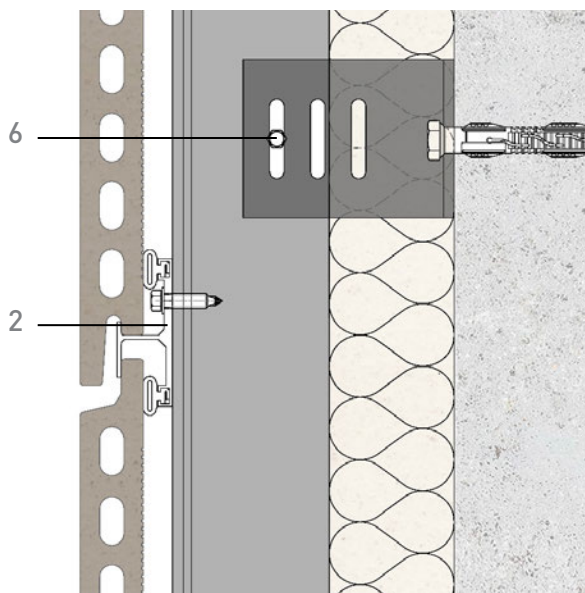

C. Placement in vertical profile
Colocación en perfil vertical

- | | | |
|--------------------------------|---|--|
| 1. Tempio tile Pieza Tempio | 5. Anchorage Anclaje | 9. Termination clip Clip de terminación |
| 2. Clip Grapa | 6. Fixed to sliding point Fijación corredera | |
| 3. Main T profile Perfil T | 7. Fixed point Fijación fija | |
| 4. Bracket Ménsula | 8. Insulating layer Aislante | |

FS SYSTEM

Fixation
Fijación

tempio®

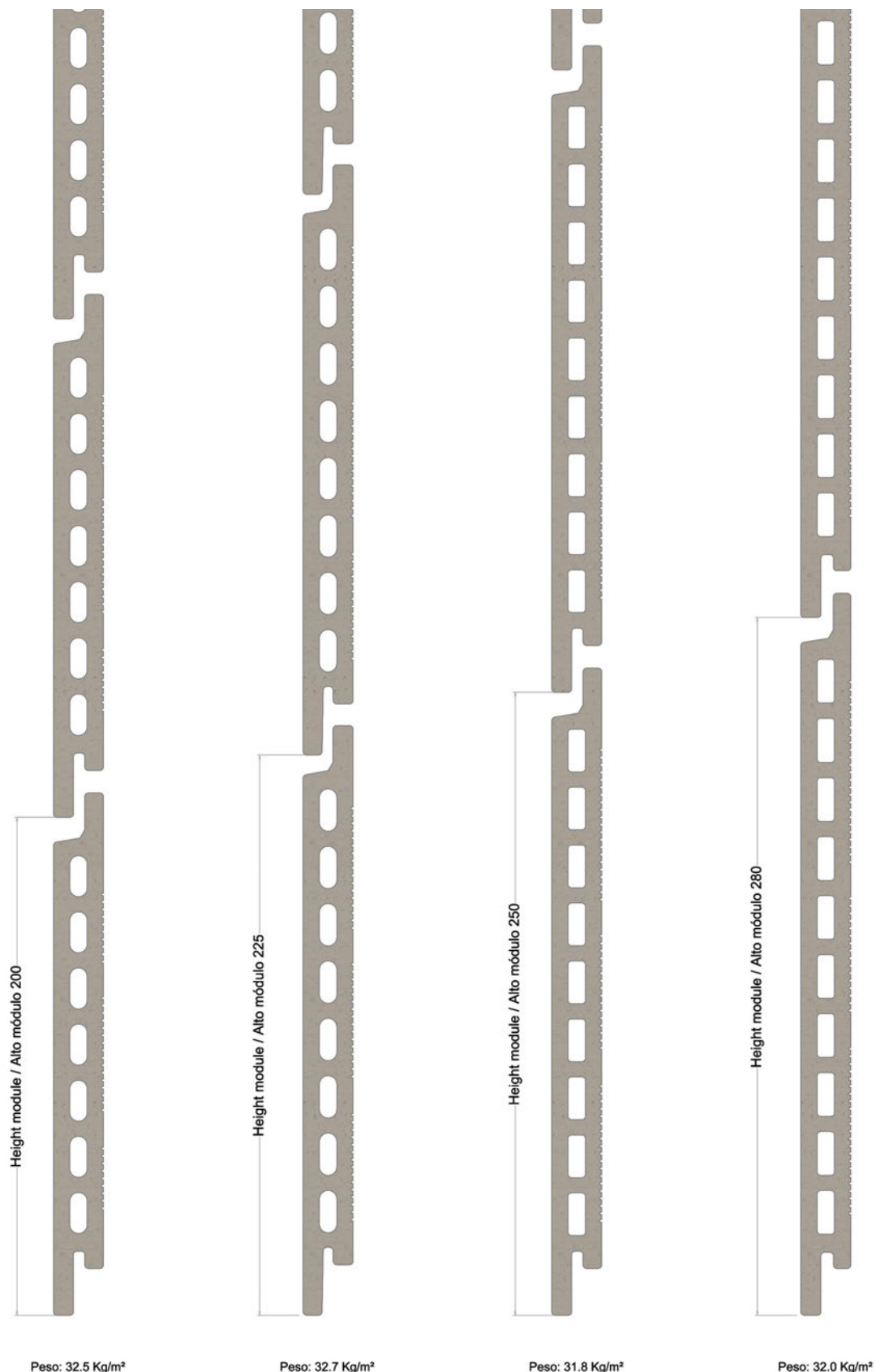

Height module / Alto módulo 200

Peso: 32.5 Kg/m²

Height module / Alto módulo 225

Peso: 32.7 Kg/m²

Height module / Alto módulo 250

Peso: 31.8 Kg/m²

Height module / Alto módulo 280

Peso: 32.0 Kg/m²

Module / Módulos:
200, 225, 250, 280

Length tile / Largo pieza:
< 1500 mm

Joint / Junta:
8-12 mm

Weight / Peso:
32,5 kg/m²
32,7 kg/m²
31,8 kg/m²
32 kg/m²

FS SYSTEM

FS-20

tempio®



Height module / Alto módulo 300

Peso: 31 Kg/m²



Height module / Alto módulo 300

Peso: 32.5 Kg/m²



Height module / Alto módulo 450

Peso: 33.0 Kg/m²



Height module / Alto módulo 500

Peso: 33.5 Kg/m²

Module / Módulos:
300a, 300b, 450, 500

Length tile / Largo pieza:
< 1500 mm

Joint / Junta:
8-12 mm

Weight / Peso:
31 kg/m²
32,5 kg/m²
33 kg/m²
33,5 kg/m²

FS SYSTEM

FS-20

tempio®

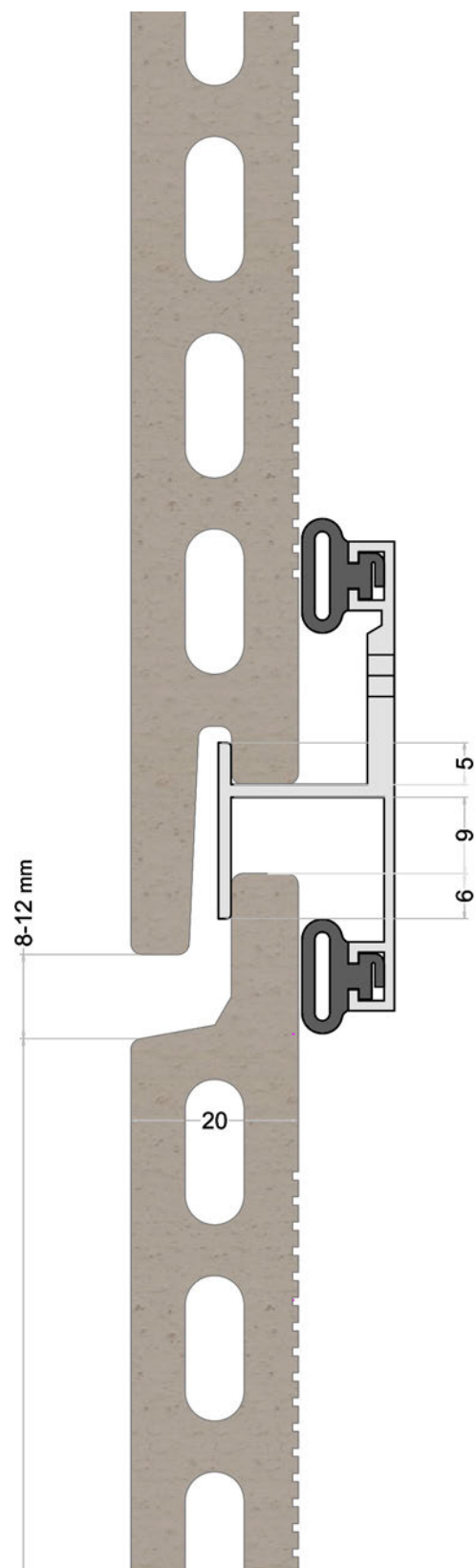
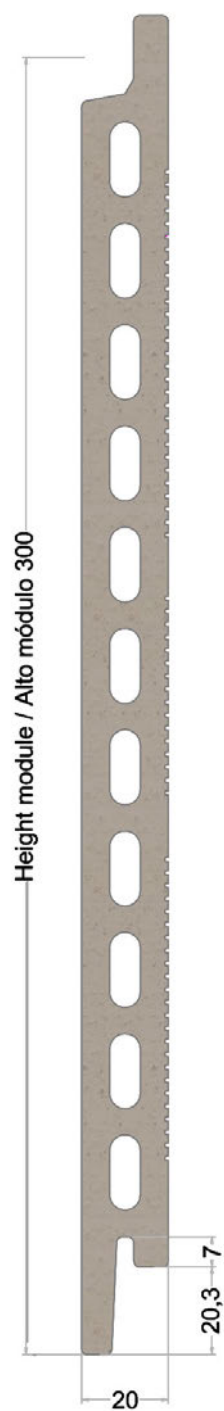

FS SYSTEM

FS-20

Module / Módulo:
300

Weight / Peso:
32 kg/m²

Joint / Junta:
8-12 mm

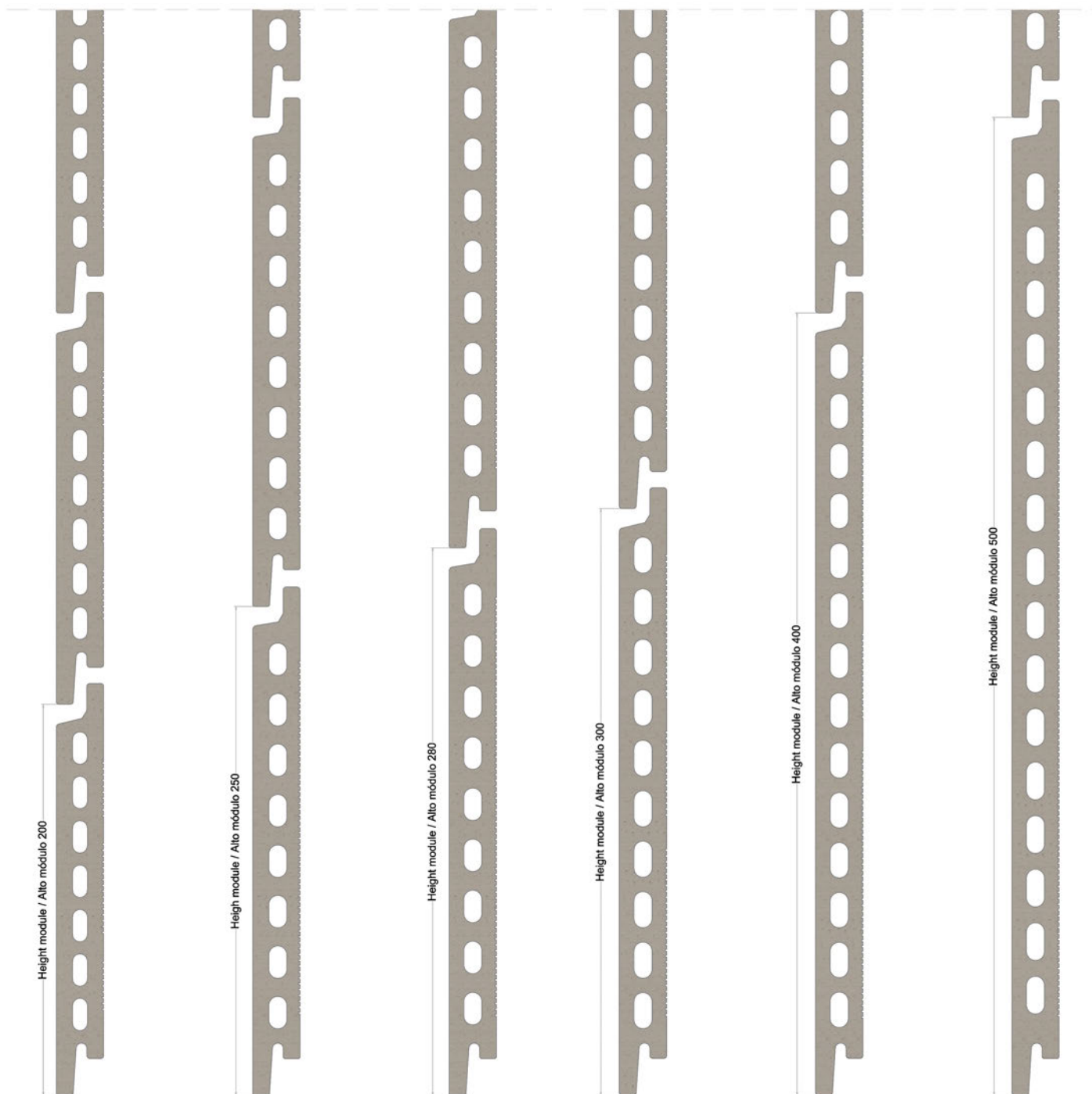

Module / Módulos:
200, 250, 280, 300,
400, 500

Length tile / Largo pieza:
< 1500 mm

Weight / Peso:
42 kg/m²

Joint / Junta:
8-12 mm

FS SYSTEM

FS-24

tempio®

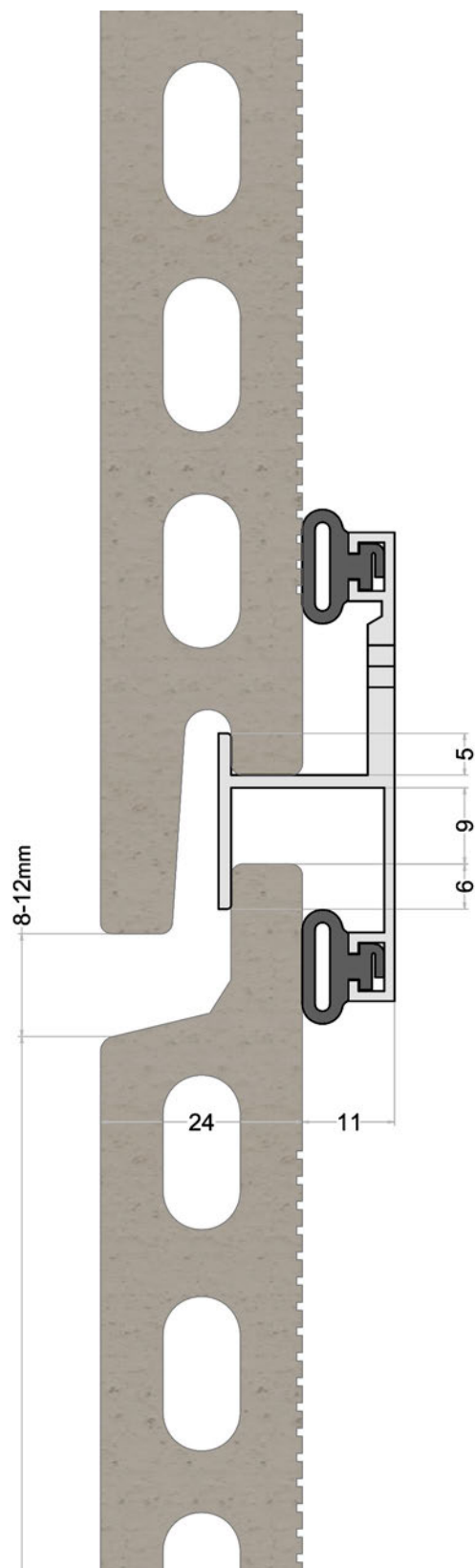
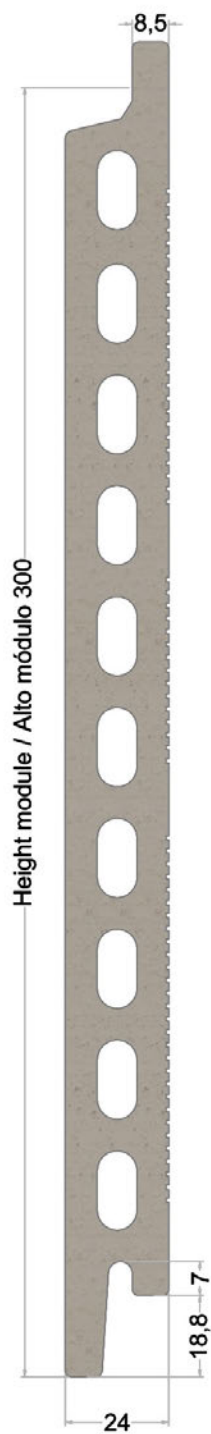

FS SYSTEM

FS-24

Module / Módulo:
300

Weight / Peso:
42 kg/m²

Joint / Junta:
8-12 mm

tempio®

2019

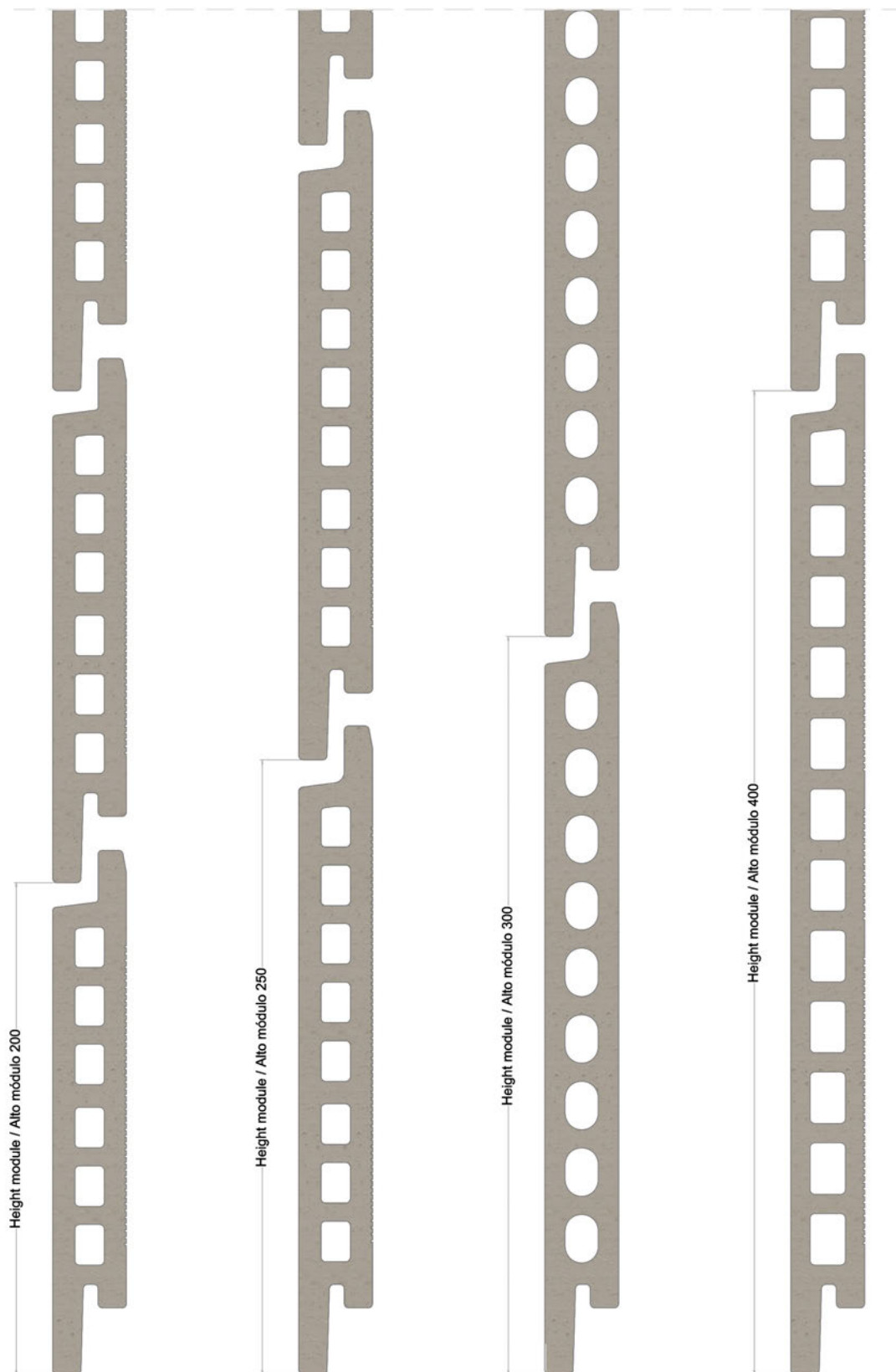

Module / Módulos:
200, 250, 300, 400

Length tile / Largo pieza:
< 1500 mm

Weight / Peso:
48 kg/m²

Joint / Junta:
8-12 mm

FS SYSTEM

FS-30

tempio®

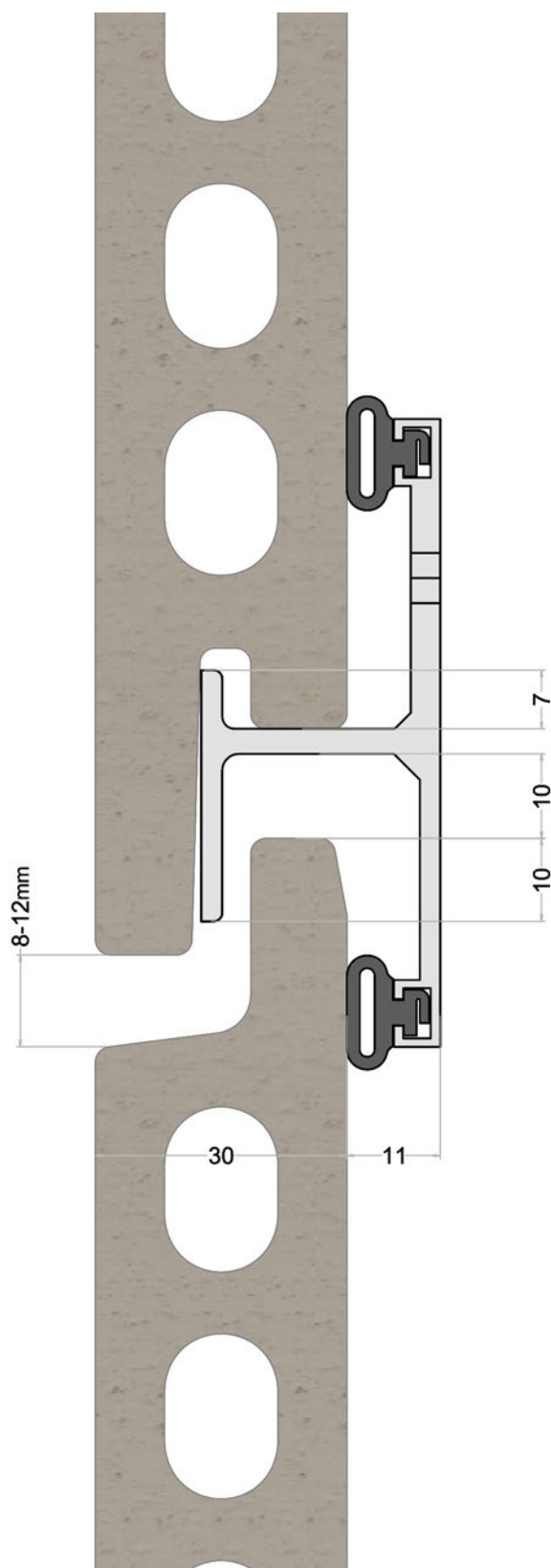
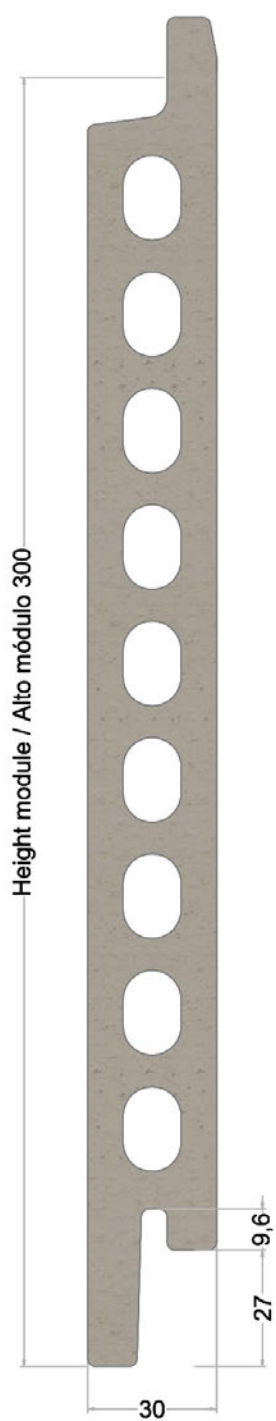

FS SYSTEM

FS-30

Module / Módulo:
300

Weight / Peso:
48 kg/m²

Joint / Junta:
8-12 mm

tempio®

2019

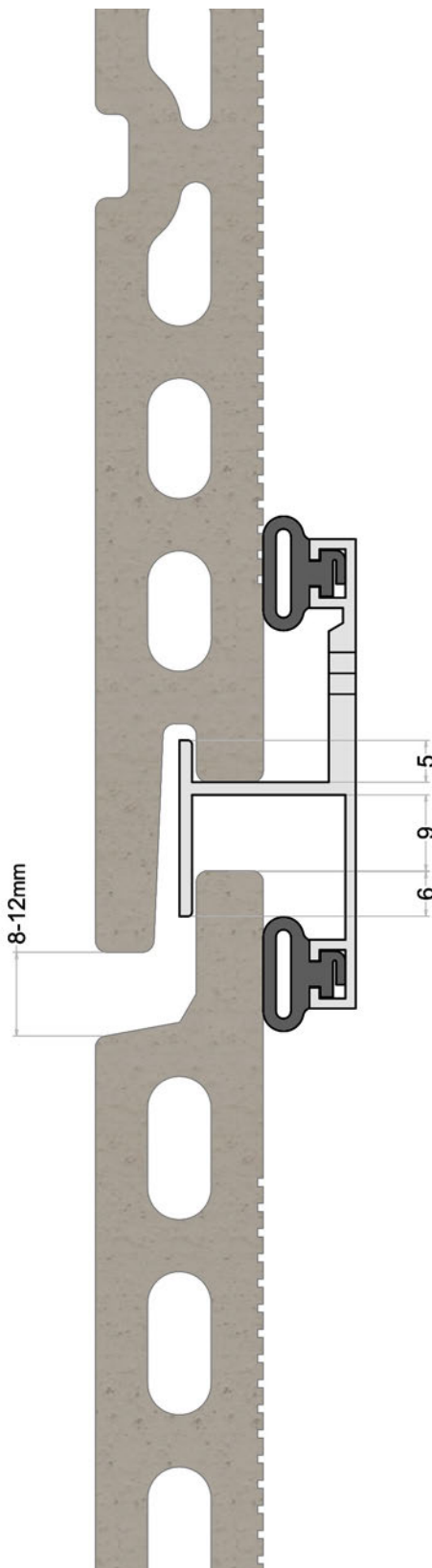
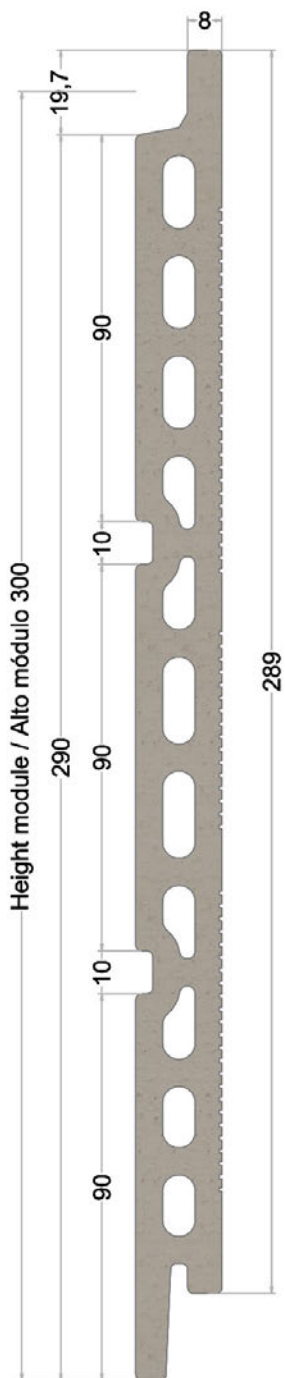

FS SYSTEM

FS-L2/20

| Module / Módulo | Weight / Peso | Joint / Junta: |
|-----------------|------------------------|----------------|
| 300 | 31,7 kg/m ² | 8-12 mm |

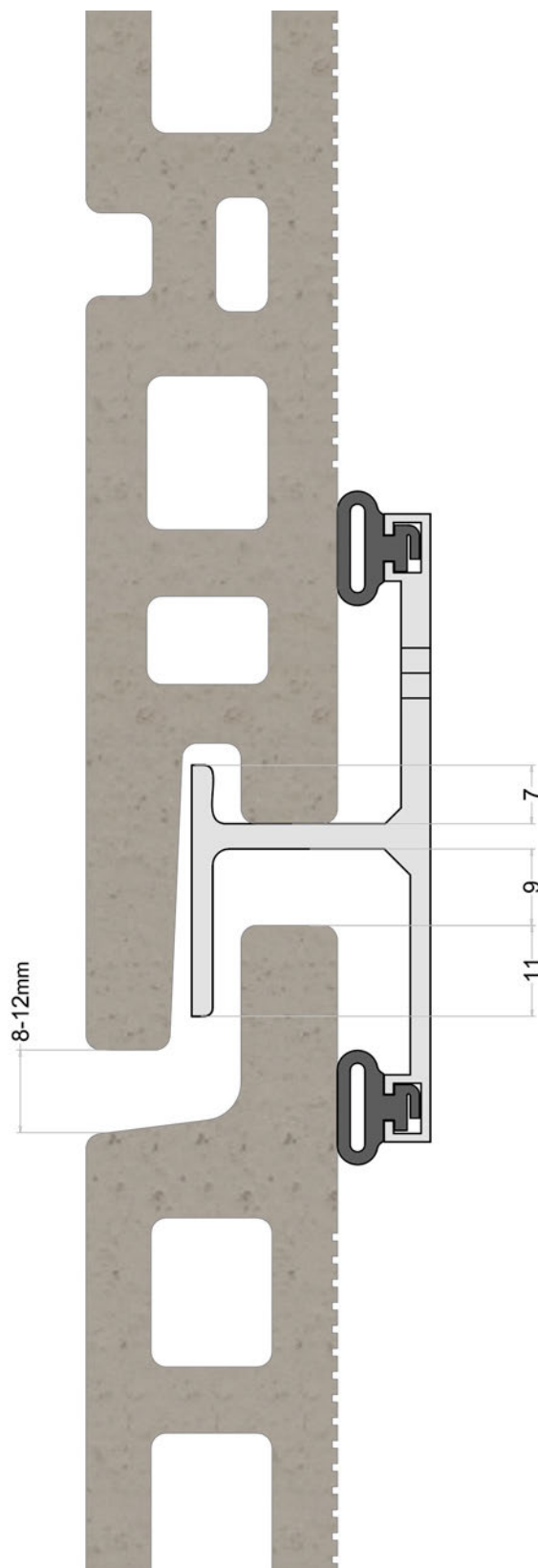
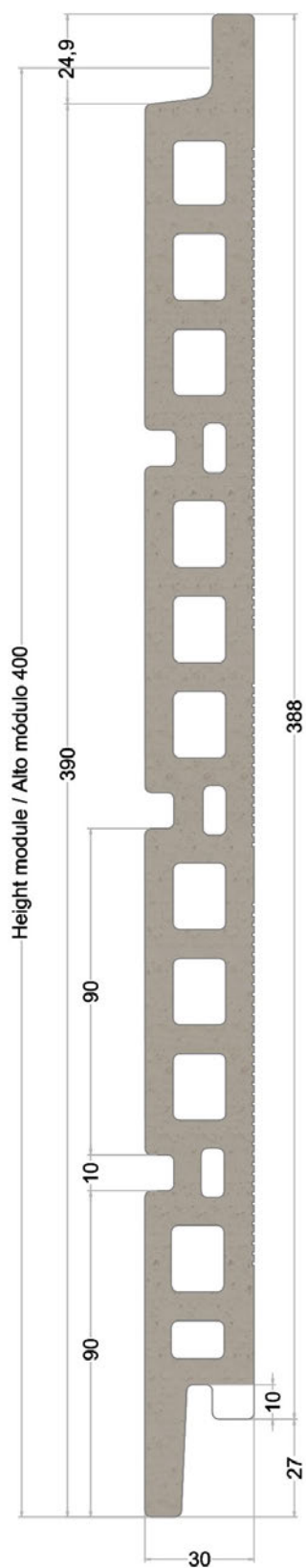

FS SYSTEM

FS-L3/30

Module / Módulo
400

Weight / Peso
45 kg/m²

Joint / Junta:
8-12 mm

tempio®

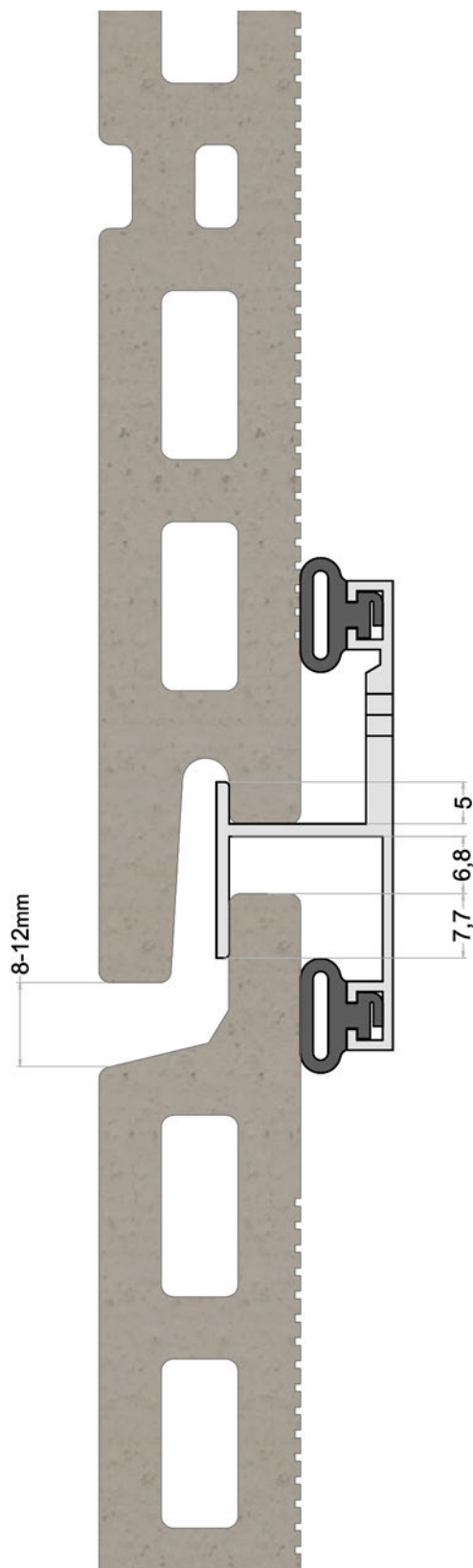
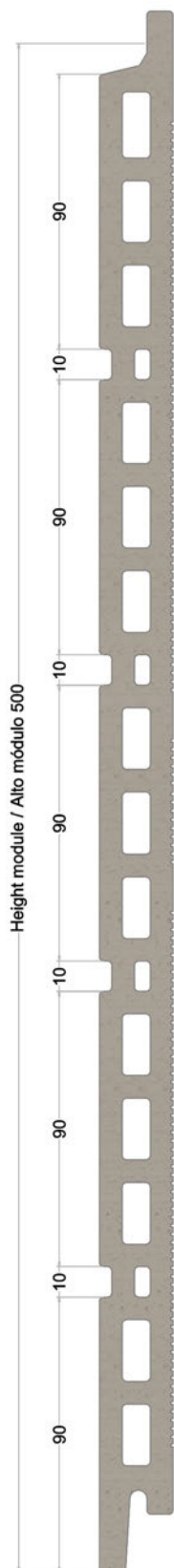

FS SYSTEM

FS-L4/24

| | | |
|------------------|----------------------|----------------|
| Module / Módulo: | Weight / Peso: | Joint / Junta: |
| 500 | 40 kg/m ² | 8-12 mm |

tempio®

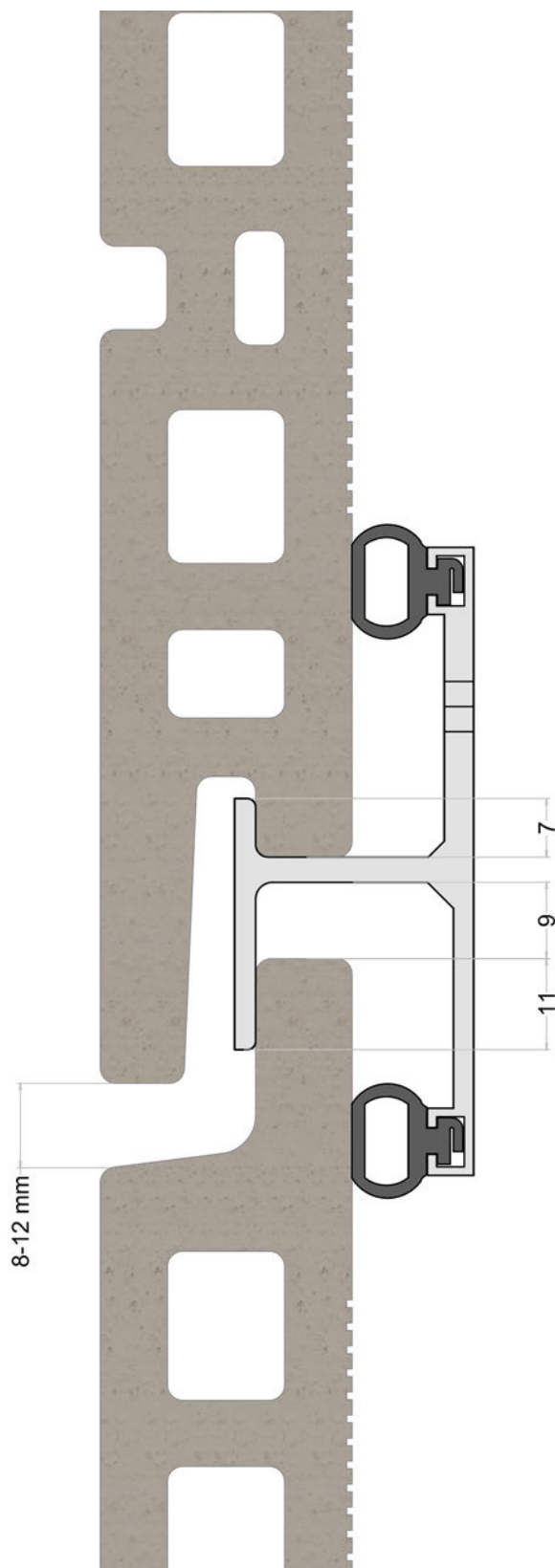
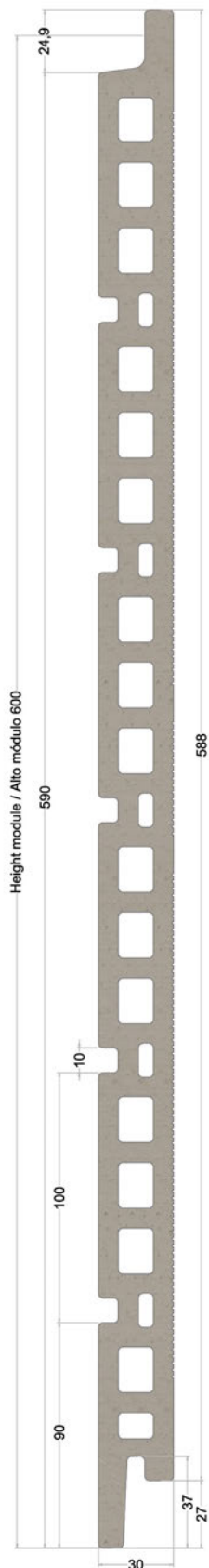

FS SYSTEM

FS-L5/30

Module / Módulo
600

Weight / Peso
45,5 kg/m²

Joint / Junta:
8-12 mm

tempio®

2019

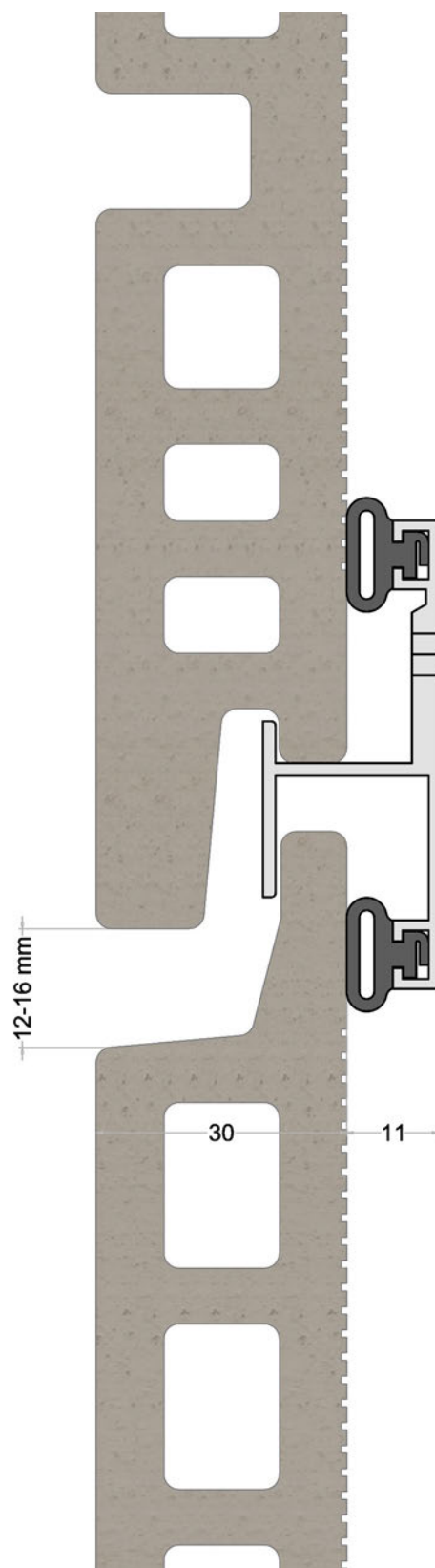
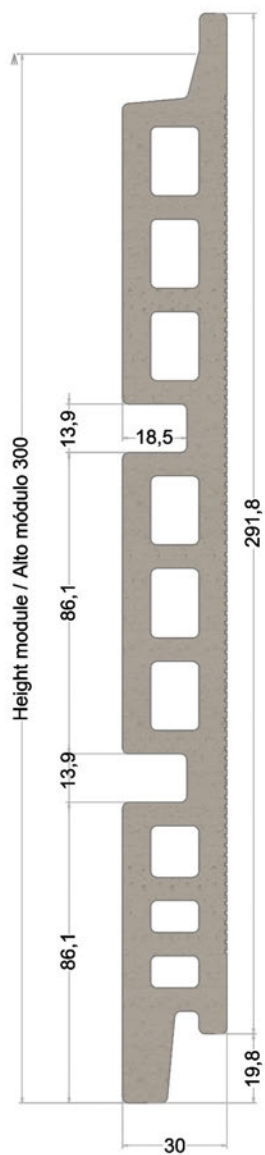

FS SYSTEM

FS-LP 2/30

Module / Módulo:
300

Weight / Peso:
42 kg/m²

Joint / Junta:
12-16 mm

tempio®

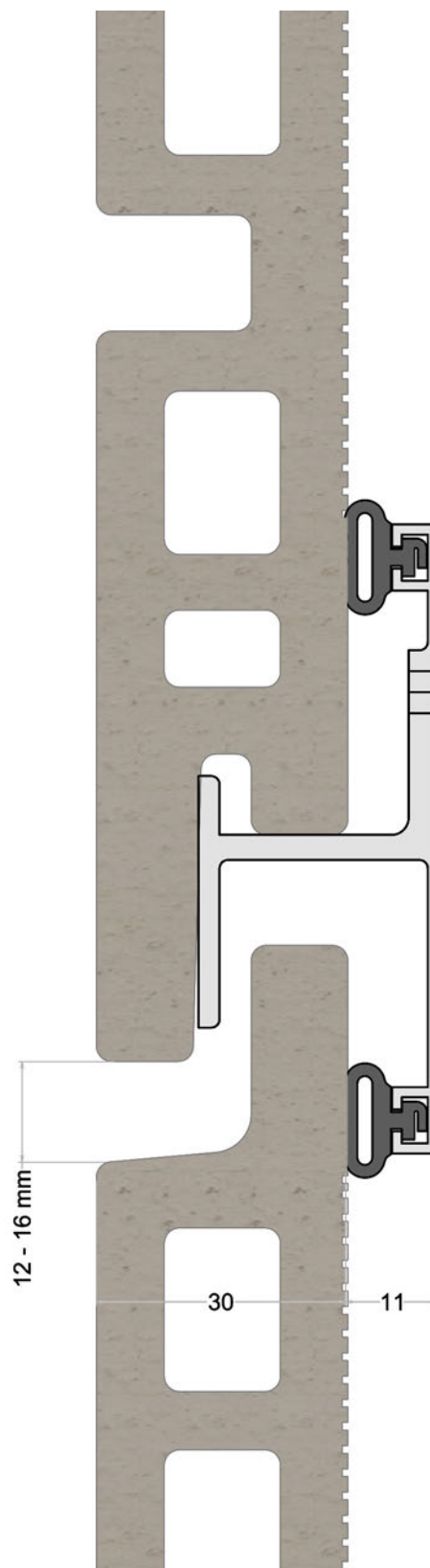
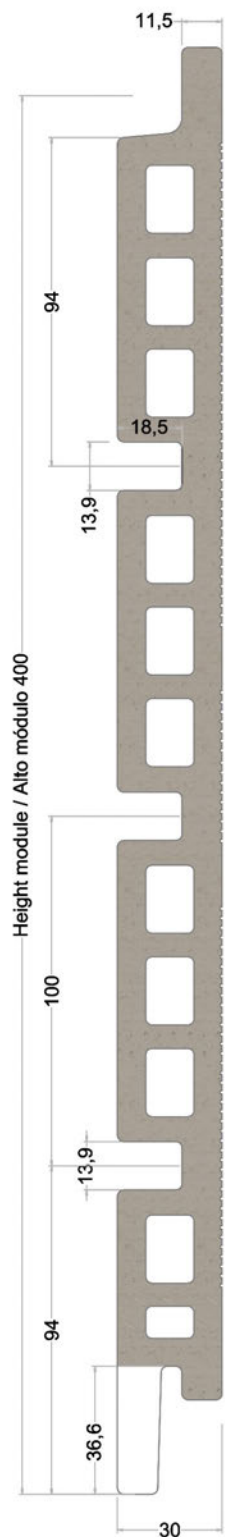

FS SYSTEM

FS-LP 3/30

Module / Módulo
400

Weight / Peso
42 kg/m²

Joint / Junta:
12-16 mm

tempio®

2019

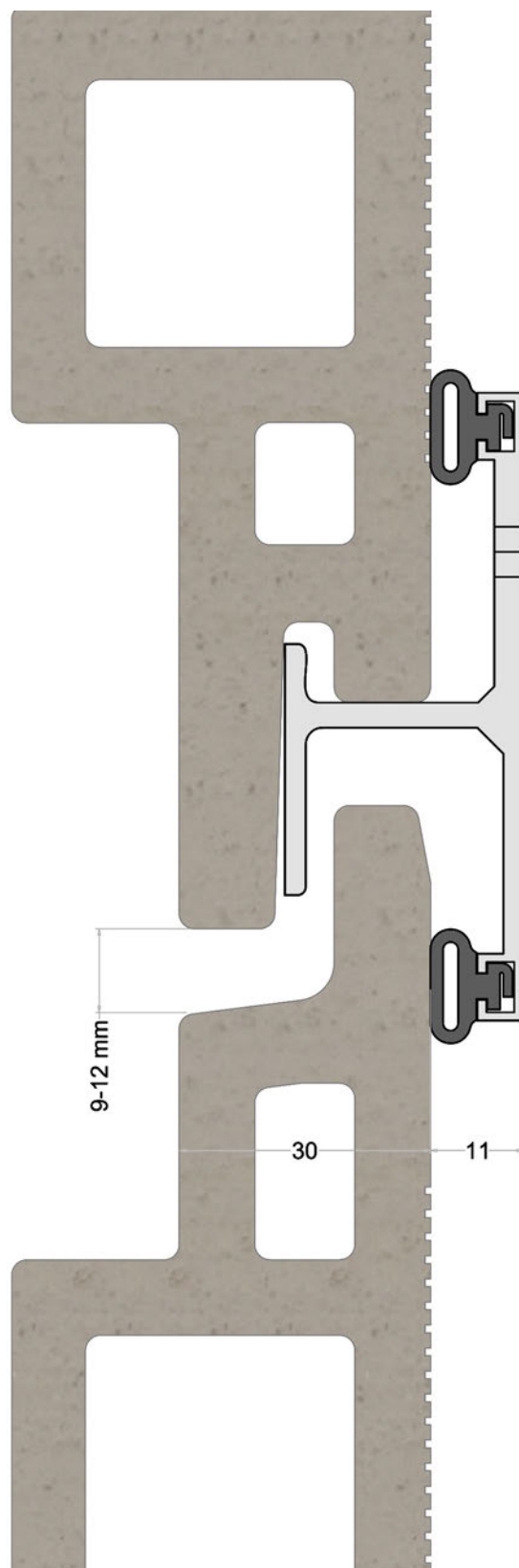
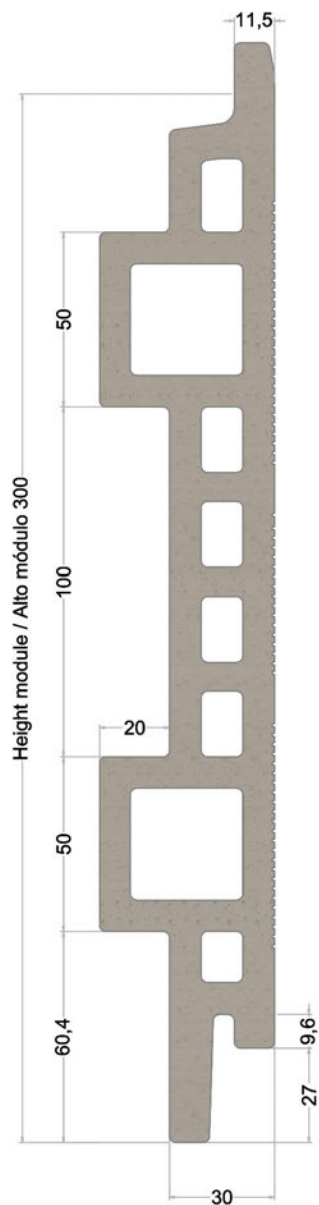

FS SYSTEM

FS-2B 5/30

Module / Módulo
300

Weight / Peso
52 kg/m²

Joint / Junta:
8-12 mm

tempio®

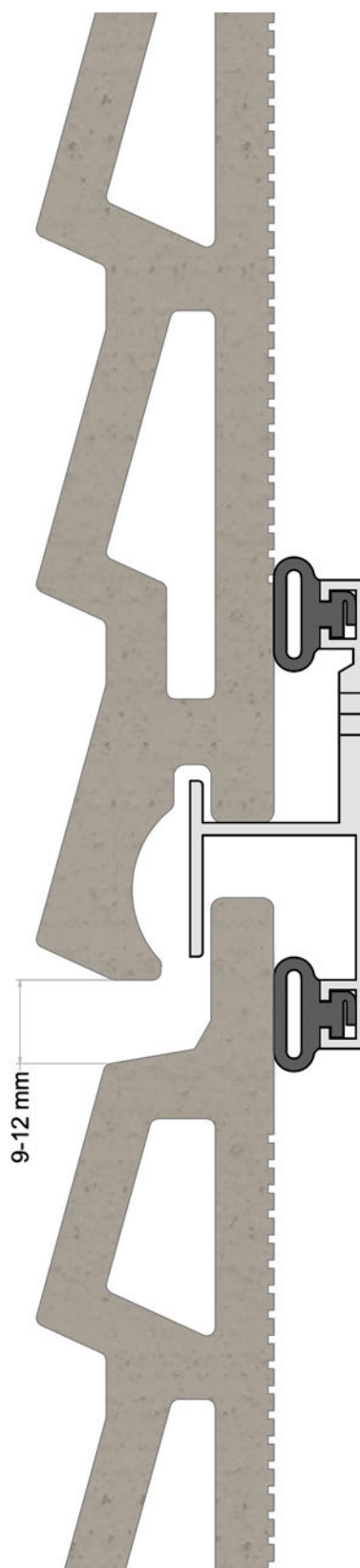
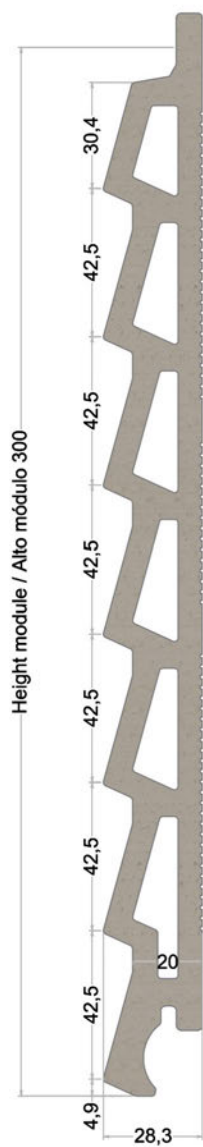

FS SYSTEM

FS-T 7/28

Module / Módulo
300

Weight / Peso
37 kg/m²

Joint / Junta:
8-12 mm

tempio®